

OFFICE CATALOGUE

ezo
B O R D



EZOBORD OFFICE MADE EASY

We're making EzoBord even easier with our quick select product guide featuring our most popular products and colors. These acoustical performance-based office products enhance the design environment of your hybrid office experience, support privacy focus spaces, or integrate separation into work modules. EzoBord has the right complement of solutions that combine aesthetics, acoustics, and design for the next generation of workspaces.

Shapes, Sizes, Colors, and Spaces

Featured are EzoBord, products offering a wide range of applications for your working office environment. From Kayra to Kulma Screens, Bench to Desk Screens, and Work Zone Dividers to our standalone Pyramid and unique Hoody solutions. EzoBord provides both style and functionality to meet your changing office needs. Multiple colors are offered to match the décor of any workspace including six popular colors that are available on all products. Configurable and easy to assemble, choose the shapes, patterns, colors, and sizes that make your space work better.

Easy

Know what you need? EzoBord has provided an easy-to-use program of high design products that complement any workspace. Please contact us to find out more and how we can assist you with any project customization. You can refer to our regional locations listed on the back cover or simply go to EzoBord.com.



EZO
B O R D | DESIGN
DRIVEN
ACOUSTICS

INDEX

COLORS	4
PYRAMID	6
OBI- MOBILE OFFICE DIVIDER	8
HOODY	10
HOODY - DESKTOP COVE	12
BENCH SCREEN SYSTEM	16
MODESTY SCREEN	18
DESK SCREEN SYSTEM	20
DESK RETURN SCREEN	22
WORK ZONE DIVIDERS MODULAR	24
KULMA CORNER SCREEN	26
KAYRA CURVED SCREEN	28
HARDWARE	30

COLOR SPLASH

DESERT SAND CODE DS10

BRICK RED CODE BR34

CHARCOAL GRAY CODE CG06

SILVER GRAY CODE SG04

MOSS GREEN CODE MG10

ROYAL BLUE CODE RB08

Select from our standard catalogue of six base colors. Looking for more colors? Our color library is both broad and deep.

Simply scan the associated QR code to explore the many options we have to satisfy your discerning palette of choice.

**SCAN TO SEE EXTENDED
COLOR RANGE HERE**



PYRAMID

SCAN FOR MORE INFO



CODE P Y R - XX - XX - XX - XXXX
 PRODUCT DEPTH HEIGHT THICKNESS COLOR

Pyramid is a free standing, wipeable, dry erase, mobile whiteboard with the added feature of a handy power/USB source. Pyramid also features acoustic panels for added sound deadening and mitigation in open plan office spaces.



POWER MODULE CODE PYR-PWR



WHITEBOARD CODE PYR-WBR

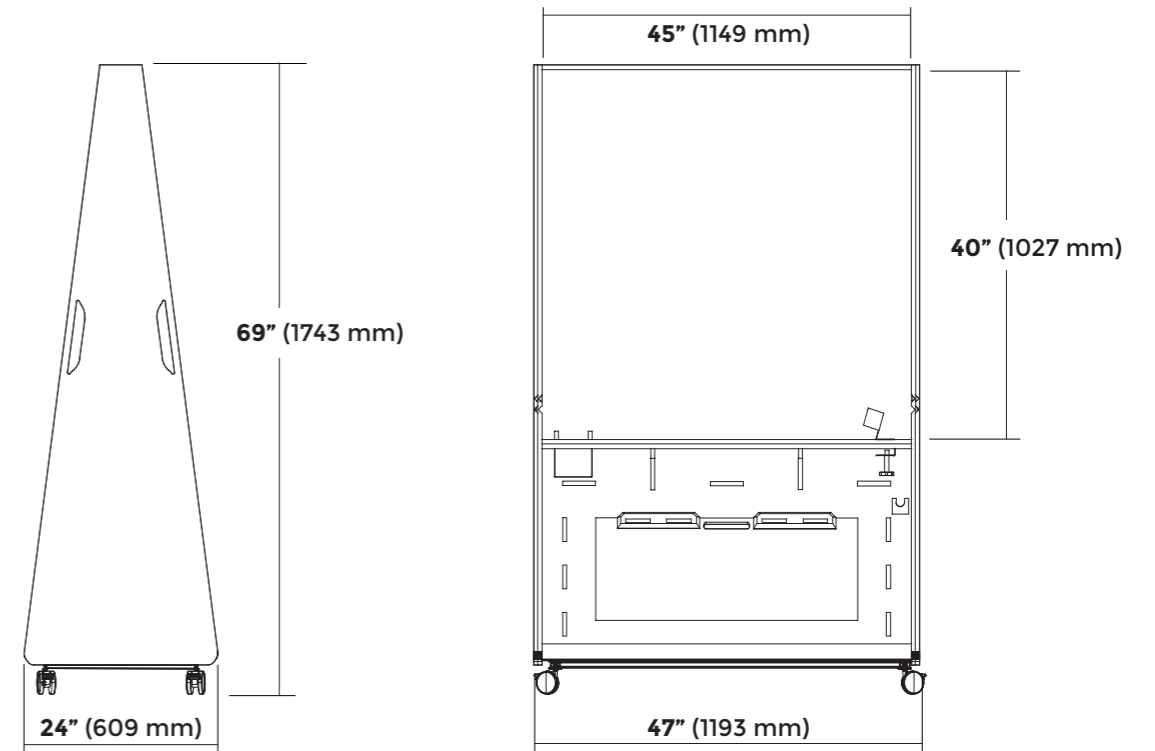

CODE	DEPTH (d)	HEIGHT (h)	WIDTH (w)	THICKNESS
PYR-24-69-12-XXXX	24" (609mm)	69" (1743mm)	47" (1193mm)	1/2" (12mm)

All dimensions indicated are nominal

COLOR CODE

DESERT SAND CODE DS10	BRICK RED CODE BR34	CHARCOAL GRAY CODE CG06	SILVER GRAY CODE SG04	MOSS GREEN CODE MG10	ROYAL BLUE CODE RB08

Please add color code on all orders: example PYR-24-69-PW-WB-12-DS10
 Custom sizes available on request. Design charges may apply.
 Colors may change and are subject to availability. Refer to website for details or contact your local sales representative.

OBI MOBILE OFFICE DIVIDER

OBI Mobile Office Divider is the perfect way to instantly transform any space into places where people meet collaborate, share and learn. Ruggedly built, totally mobile and 'nestable', OBI Mobile Office Divider features EzoBord acoustical surface materials and are available in a variety of visually interesting patterns. OBI Mobile Office Divider is also available with magnetic rewriteable surface options and shelf and file storage options making them perfect for multi task/meeting environments.



SUGGESTED CONFIGURATIONS



SCAN FOR MORE INFO



CODE **O B 2 - X X X - X X - X X - X X X - X X X - X X X X**
PRODUCT STYLE WIDTH HEIGHT PATTERN COLOR (BASE LAYER*) COLOR (SURFACE LAYER*)

STYLE

PLAIN BOTH SIDES CODE **EZO**

PLAIN ONE SIDE, WHITEBOARD
OTHER SIDE CODE **PLW**

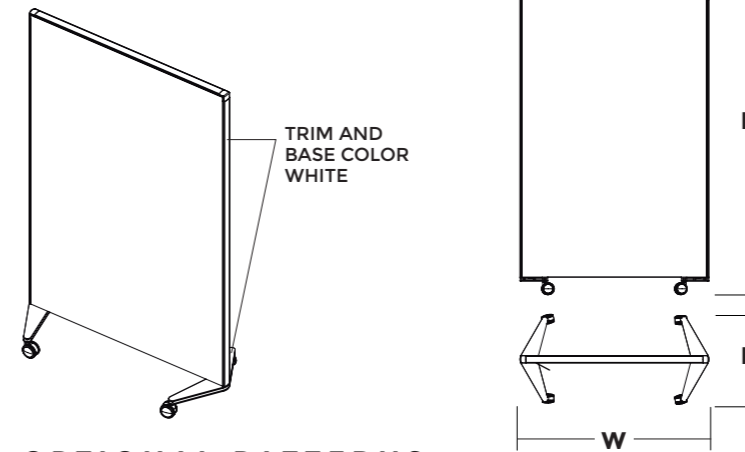

WHITEBOARD SHELF
 CODE **OB2-SHF-47-08-12**

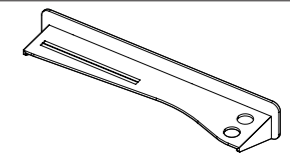

WHITEBOARD SHELF
 CODE **OB2-FIL-15-14-12**

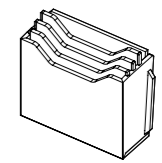

OPTIONAL PATTERNS



BAMBOO
 CODE **BAM**

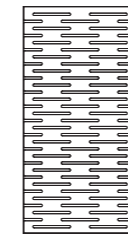

SLOTTED
 CODE **SLT**



STAGGERED
 CODE **STG**

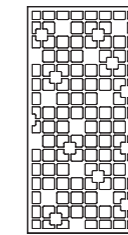

LATTICE
 CODE **LIT**

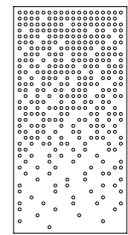

PIXELATED CIRCLES
 CODE **PXC**

CODE	DEPTH (D)	HEIGHT (H)	WIDTH (W)
OB2-EZO-48-60-XXX-XXXX	48" (1219mm)	60" (1524mm)	21.5" (546mm)
OB2-PLW-48-60-XXXX	48" (1219mm)	60" (1524mm)	21.5" (546mm)
OB2-EZO-48-72-XXX-XXXX	48" (1219mm)	72" (1828mm)	21.5" (546mm)
OB2-PLW-48-72-XXXX	48" (1219mm)	72" (1828mm)	21.5" (546mm)

All dimensions indicated are nominal

COLOR CODE (BASE LAYER)



COLOR CODE



Please add color code on all orders: example **PYR-24-69-PW-WB-12-DS10**
 Custom sizes available on request. Design charges may apply.
 Colors may change and are subject to availability. Refer to website for details or contact your local sales representative.

HOODY

SCAN FOR MORE INFO



Instantly transform your open plan office space into individually separated, quiet workspaces with EzoBord's modular Hooded Desk divider system nicknamed "Hoody". The "Hoody" installs in seconds without the use of any tools and fits onto any new or existing desking/benching system. Compatible with virtually any manufacturer including all major office furniture brands.



BACK SCREEN

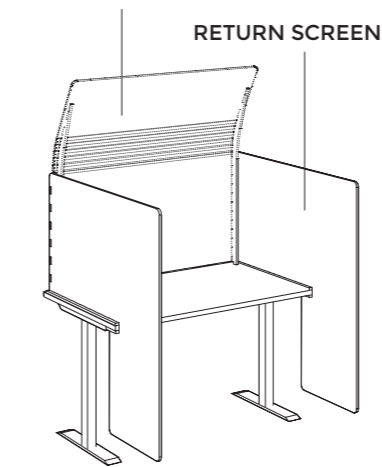

Desk not included

BACK SCREEN

CODE H D S - B S X - X X - X X - X X - X X X X
PRODUCT SIZE CODE WIDTH HEIGHT THICKNESS COLOR

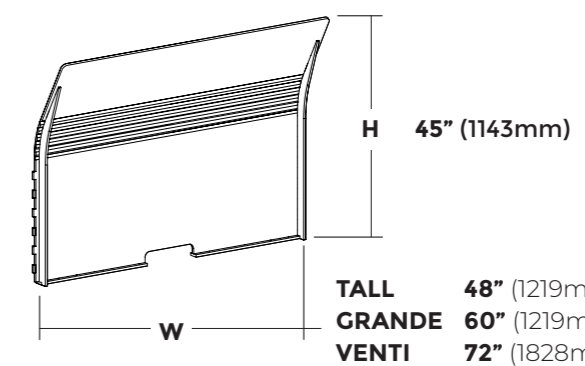

Standard cable management/monitor arm cut-out: 11" (280mm) w x 3" (75mm) h

CODE	WIDTH (W)	HEIGHT (H)	THICKNESS
HDS-BST-48-45-12-XXXX	48" (1219mm)	45" (1143mm)	1/2" (12mm)
HDS-BSG-60-45-12-XXXX	60" (1524mm)	45" (1143mm)	1/2" (12mm)
HDS-BSV-72-45-12-XXXX	72" (1828mm)	45" (1143mm)	1/2" (12mm)

All dimensions indicated are nominal

RETURN SCREEN

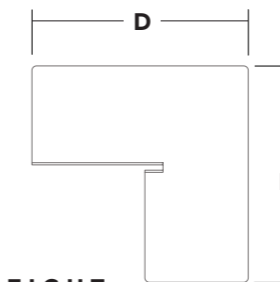

FULL HEIGHT RETURN SCREEN
CODE RSF

CODE H D S - R S X - X X - X X - X X - X X X X
PRODUCT STYLE DEPTH HEIGHT THICKNESS COLOR

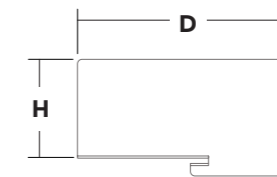

EXTENDED RETURN SCREEN
CODE RSE

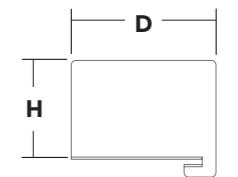

RETURN SCREEN
CODE RSS

CODE	DEPTH (D)	HEIGHT (H)	THICKNESS
HDS-RSS-24-24-12-XXXX	24" (609mm)	24" (609mm)	1/2" (12mm)
HDS-RSS-24-30-12-XXXX	30" (762mm)	24" (609mm)	1/2" (12mm)
HDS-RSE-24-24-12-XXXX	24" (609mm)	24" (609mm)	1/2" (12mm)
HDS-RSE-30-24-12-XXXX	30" (762mm)	24" (609mm)	1/2" (12mm)
HDS-RSF-24-47-12-XXXX	24" (609mm)	47" (1193mm)	1/2" (12mm)
HDS-RSF-30-47-12-XXXX	30" (762mm)	47" (1193mm)	1/2" (12mm)

All dimensions indicated are nominal

COLOR CODE

DESERT SAND CODE DS10	BRICK RED CODE BR34	CHARCOAL GRAY CODE CG06	SILVER GRAY CODE SG04	MOSS GREEN CODE MG10	ROYAL BLUE CODE RB08

Please add color code on all orders: example PYR-24-69-PW-WB-12-DS10
 Custom sizes available on request. Design charges may apply.
 Colors may change and are subject to availability. Refer to website for details or contact your local sales representative.

HOODY DESKTOP COVE

SCAN FOR MORE INFO



Inspired by the classic Hoody Desk Screen system, Hoody Desktop Cove creates a unique personal space including super convenient 'built in' corner shelves to hold your Bluetooth speakers or other items you wish to have in your personal workspace. Hoody Desktop Cove is tailor-made to fit any height adjustable or fixed height desk sold by virtually any office furniture brand.



CODE **HDC - DTX - XX - XX - XX - XX - XXXX**
PRODUCT STYLE DEPTH WIDTH HEIGHT THICKNESS COLOR

STYLE

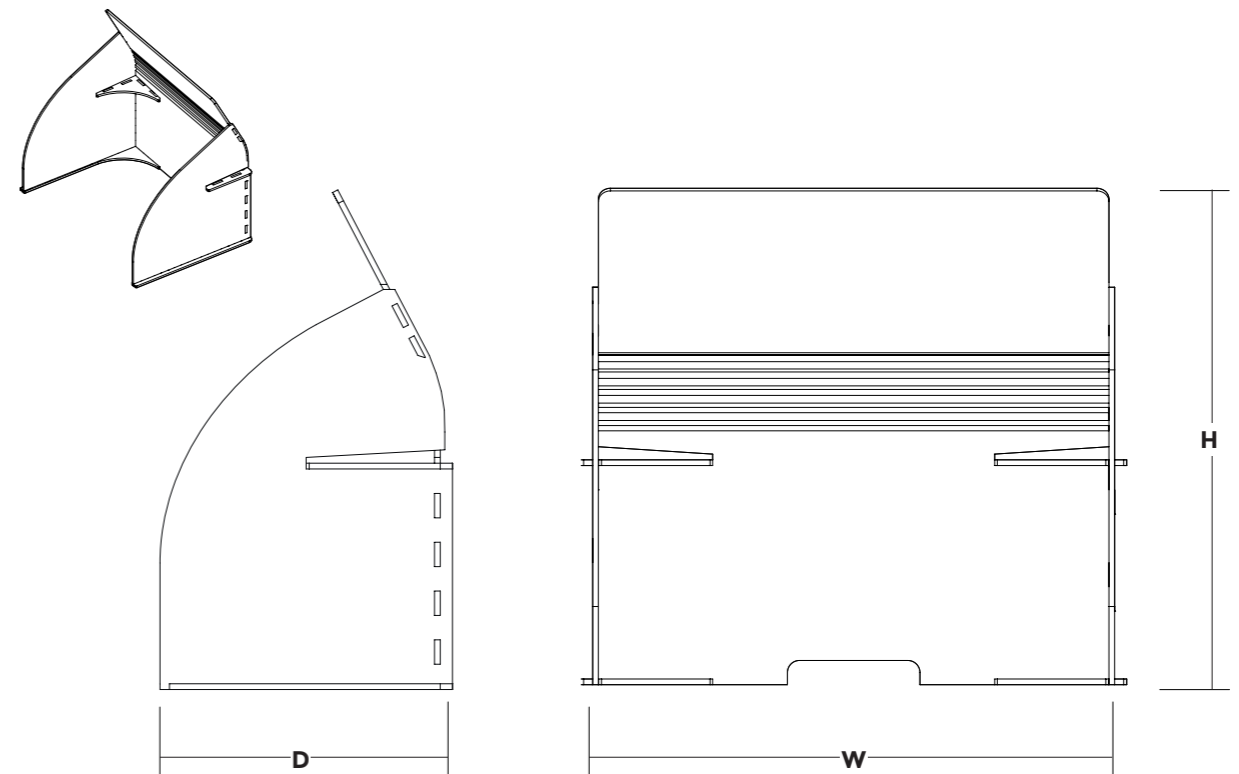

TALL 48" (1219mm) CODE **DTT**
GRANDE 60" (1219mm) CODE **DTG**
VENTI 72" (1828mm) CODE **DTV**

Standard cable mangement/monitor arm cut-out: 11" (280mm) w x 3" (75mm) h

CODE	DEPTH (D)	WIDTH (W)	HEIGHT (H)
HDC-DTT-24-48-40-12-XXXX	24" (609mm)	48" (1219mm)	40" (1040mm)
HDC-DTG-30-60-40-12-XXXX	30" (762mm)	60" (1524mm)	40" (1040mm)
HDC-DTV-30-72-40-12-XXXX	30" (762mm)	72" (1828mm)	40" (1040mm)

COLOR CODE



Please add color code on all orders: example PYR-24-69-PW-WB-12-DS10
 Custom sizes available on request. Design charges may apply.
 Colors may change and are subject to availability. Refer to website for details or contact your local sales representative.



PYRAMID

BENCH SCREEN SYSTEM

HOODY

MODESTY SCREEN

SCAN FOR MORE INFO



CODE **M S C - X X X - X X - X X - X X - X X X X**
PRODUCT STYLE WIDTH HEIGHT THICKNESS COLOR

EzoBord Modesty Screens are a great way to absorb sound, add privacy, color, and style in any open plan workspace. It enhances speech intelligibility making every office space a better place to work. This product is a welcome addition to any open plan office and is totally customizable for size, shape, hole pattern, and color. It is also available in single or double layer to accommodate any budget or design. EzoBord Desk Screens are a great eco-friendly alternative to fabric-covered desk screens.



STYLE

ELLIPTICAL
CODE ELP

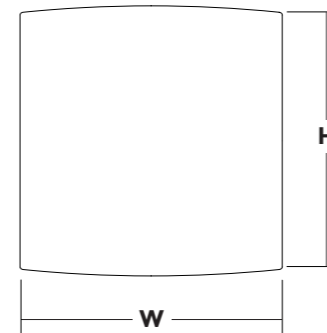

RECTANGLE
CODE REC

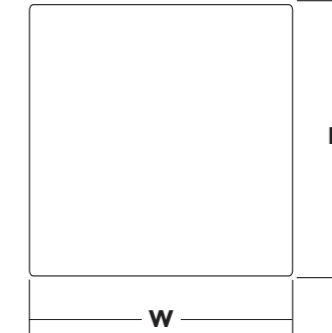

HARDWARE

PJ-15/17
(Sold Separately)

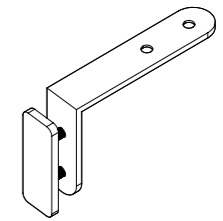

Custom Shapes Also Available

CODE	DESK WIDTH (W)	DESK HEIGHT (H)	THICKNESS
MSC-ELP-48-48-12-XXXX	48" (1219mm)	48" (1219mm)	1/2" (12mm)
MSC-ELP-60-48-12-XXXX	60" (1524mm)	48" (1219mm)	1/2" (12mm)
MSC-ELP-72-48-12-XXXX	72" (1828mm)	48" (1219mm)	1/2" (12mm)
MSC-REC-48-48-12-XXXX	48" (1219mm)	48" (1219mm)	1/2" (12mm)
MSC-REC-60-48-12-XXXX	60" (1524mm)	48" (1219mm)	1/2" (12mm)
MSC-REC-72-48-12-XXXX	72" (1828mm)	48" (1219mm)	1/2" (12mm)

All dimensions indicated are nominal

COLOR CODE

DESERT SAND CODE DS10	BRICK RED CODE BR34	CHARCOAL GRAY CODE CG06	SILVER GRAY CODE SG04	MOSS GREEN CODE MG10	ROYAL BLUE CODE RB08

*Please add color code on all orders: example PYR-24-69-PW-WB-12-DS10
 Custom sizes available on request. Design charges may apply.
 Colors may change and are subject to availability. Refer to website for details or contact your local sales representative.*

DESK SCREEN SYSTEM

SCAN FOR MORE INFO



EzoBord Desk Screens are a great way to absorb sound, add privacy, color, and style in any open plan workspace. It enhances speech intelligibility making every office space a better place to work. This product is a welcome addition to any open plan office and is totally customizable for size, shape, hole pattern, and color. It is also available in single or double layer to accommodate any budget or design. EzoBord Desk Screens are a great eco-friendly alternative to fabric-covered desk screens.



CODE D S C - X X X - X X - X X - X X - X X X X
 PRODUCT STYLE WIDTH HEIGHT THICKNESS COLOR

STYLE

CIRCULAR
CODE CIR

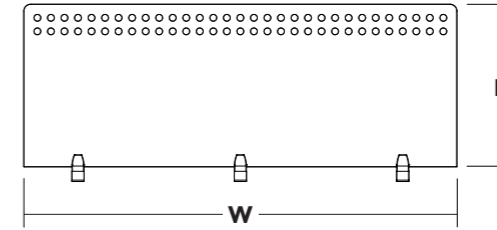

ELLIPTICAL
CODE ELP

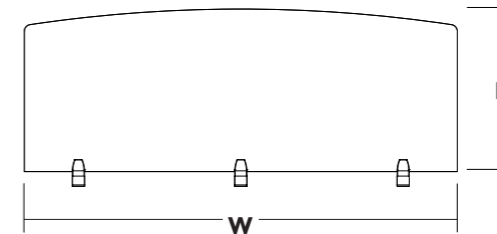

RECTANGLE
CODE REC

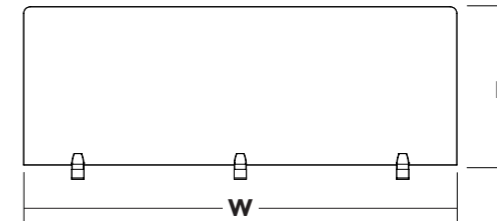

HARDWARE

PJ-101

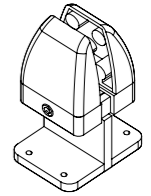

PJ-3

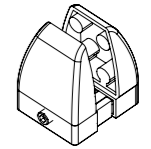

PJ-4

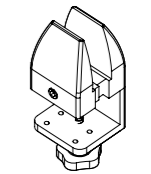

Custom Shapes Also Available

CODE	DESK WIDTH (W)	DESK HEIGHT (H)	THICKNESS
DSC-CIR-48-XX-12-XXXX	48" (1219mm)	15" (400mm) or 24" (609mm)	1/2" (12mm)
DSC-CIR-60-XX-12-XXXX	60" (1524mm)	15" (400mm) or 24" (609mm)	1/2" (12mm)
DSC-CIR-72-XX-12-XXXX	72" (1828mm)	15" (400mm) or 24" (609mm)	1/2" (12mm)
DSC-ELP-48-XX-12-XXXX	48" (1219mm)	15" (400mm) or 24" (609mm)	1/2" (12mm)
DSC-ELP-60-XX-12-XXXX	60" (1524mm)	15" (400mm) or 24" (609mm)	1/2" (12mm)
DSC-ELP-72-XX-12-XXXX	72" (1828mm)	15" (400mm) or 24" (609mm)	1/2" (12mm)
DSC-REC-48-XX-12-XXXX	48" (1219mm)	15" (400mm) or 24" (609mm)	1/2" (12mm)
DSC-REC-60-XX-12-XXXX	60" (1524mm)	15" (400mm) or 24" (609mm)	1/2" (12mm)
DSC-REC-72-XX-12-XXXX	72" (1828mm)	15" (400mm) or 24" (609mm)	1/2" (12mm)

All dimensions indicated are nominal

COLOR CODE

DESERT SAND CODE DS10	BRICK RED CODE BR34	CHARCOAL GRAY CODE CG06	SILVER GRAY CODE SG04	MOSS GREEN CODE MG10	ROYAL BLUE CODE RB08

Please add color code on all orders: example PYR-24-69-PW-WB-12-DS10

Custom sizes available on request. Design charges may apply.

Colors may change and are subject to availability. Refer to website for details or contact your local sales representative.

DESK RETURN SCREEN

SCAN FOR MORE INFO



CODE **RTS - XX - XX - XX - XXXX**
PRODUCT DEPTH HEIGHT THICKNESS COLOR

Desk Return Screens are a simple and effective way to ensure privacy and deaden sound between bench style desks and workstations. Available in a range of both colors and high performance acoustic properties.



HARDWARE

PJ-101

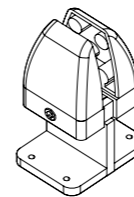

PJ-3

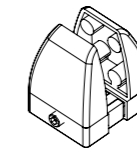

PJ-4

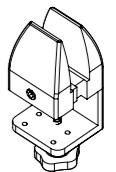

CODE	WIDTH (W)	HEIGHT (H)	THICKNESS
RTS-20-XX-12-XXXX	20" (508mm)	16" (400mm) or 24" (609mm)	1/2" (12mm)
RTS-24-XX-12-XXXX	24" (609mm)	16" (400mm) or 24" (609mm)	1/2" (12mm)
RTS-30-XX-12-XXXX	24" (609mm)	16" (400mm) or 24" (609mm)	1/2" (12mm)

All dimensions indicated are nominal

COLOR CODE

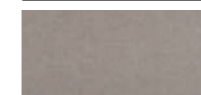

DESERT SAND
CODE DS10



BRICK RED
CODE BR34



CHARCOAL GRAY
CODE CG06



SILVER GRAY
CODE SG04



MOSS GREEN
CODE MG10



ROYAL BLUE
CODE RB08



RTS-24-16-12-SG04



RTS-30-16-12-RB08



RTS-24-24-12-MG10

Please add color code on all orders: example PYR-24-69-PW-WB-12-DS10

Custom sizes available on request. Design charges may apply.

Colors may change and are subject to availability. Refer to website for details or contact your local sales representative.

WORK ZONE DIVIDER MODULAR

SCAN FOR MORE INFO



CODE **W Z M - X X X - X X X - X X - X X - X X X X**
PRODUCT PATTERN WIDTH LENGTH THICKNESS COLOR

Work Zone Dividers Modular have key distinguishing features for the design illuminati. It can be comprised of one, two or three modules allowing you to create a truly spectacular parameter division. Still porous to allow light, but boldly applied for design intent. This product can be mounted in sections at different heights for added effect, something that the standard single piece Work Zone Dividers cannot accomplish.



MODULES

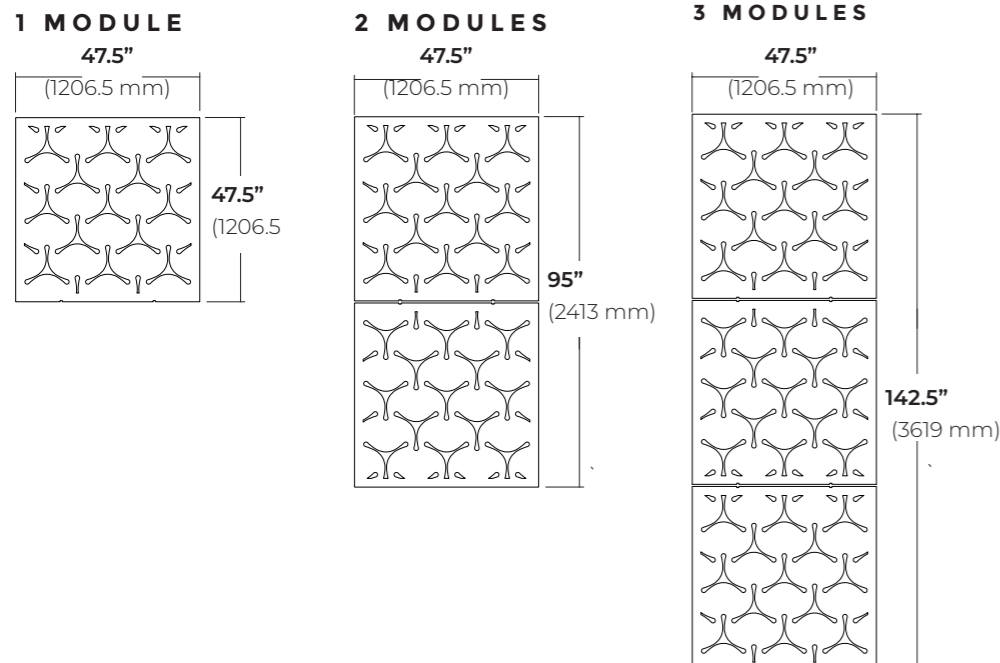

HARDWARE

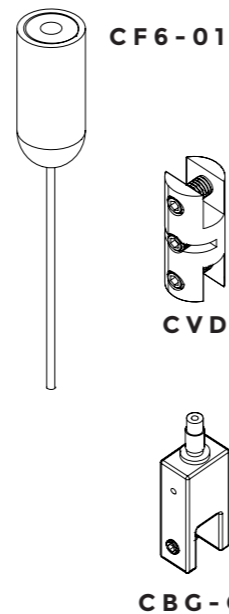

TIER A PATTERNS

BAMBOO CODE BAM	CHEVRON CODE CHE	CUBE CODE CUB	DECO CODE DEC	FLATLINE CODE FLA	GALAXY CODE GLX	LEAF CODE LEA	JACK CODE JAC
LAVA CODE LAV	FOCUS CODE FOC	NOTES PLUS CODE NOP	BOOMERANG CODE BOO				

TIER B PATTERNS

AZTEC CODE AZ	DOKUMA CODE DOK	KESIK CODE KES	LAZER CODE LAZ	PIXELATED CIRCLES CODE PXC	ORMAN CODE ORM	LATTICE CODE LAT	PIXELATED SQUARES CODE PXS
SCALES CODE SCA	PHOTON CODE PHO	HOURGLASS CODE HOU	HIVE CODE HIE	TURBINE CODE TUR	SONAR CODE SON	HATCH CODE HAT	HONEYCOMB CODE HOU

CODE	WIDTH	LENGTH	THICKNESS
WZM-XXX-48-XX-12-XXXX	47.5" (1206mm)	47.5" (1206mm) or 95" (2413mm) 142.5" (3619mm)	1/2" (12mm)

All dimensions indicated are nominal

COLOR CODE

DESERT SAND CODE DS10	BRICK RED CODE BR34	CHARCOAL GRAY CODE CG06	SILVER GRAY CODE SG04	MOSS GREEN CODE MG10	ROYAL BLUE CODE RB08

Please add color code on all orders: example PYR-24-69-PW-WB-12-DS10
 Custom sizes available on request. Design charges may apply.
 Colors may change and are subject to availability. Refer to website for details or contact your local sales representative.

KULMA CORNER SCREEN

SCAN FOR MORE INFO



Kulma Corner Screens absorb sound, divide space and ensure complete privacy at your workspace. Available in a range of styles and colors to suit any office interior.



CODE **K L S - X X - X X - X X - X X - X X - X X - X X X X**
 PRODUCT SHAPE CODE DEPTH WIDTH HEIGHT 1 HEIGHT 2 THICKNESS COLOR

SINGLE HEIGHT CODE SH

VARIABLE HEIGHT CODE SH

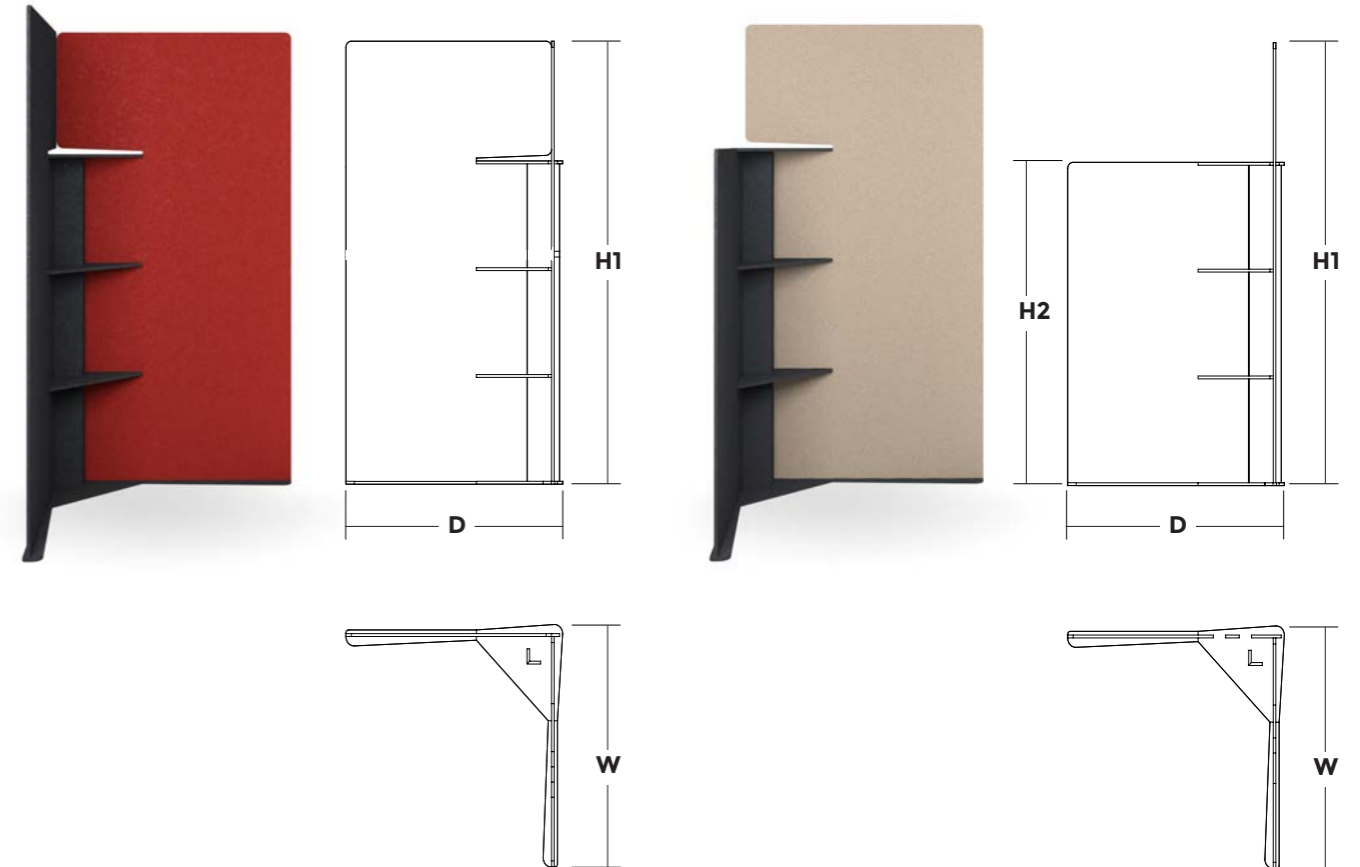

CODE	DEPTH (W)	WIDTH (W)	HEIGHT (H1)	HEIGHT (H2)	THICKNESS
KLS-SH-40-40-73-73-12-XXXX	40" (1016mm)	73" (1854mm)	73" (1855mm)	73" (1855mm)	1/2" (12mm)
KLS-VH-40-40-73-53-12-XXXX	40" (1016mm)	73" (1854mm)	73" (1855mm)	53" (1854mm)	1/2" (12mm)

COLOR CODE



Please add color code on all orders: example PYR-24-69-PW-WB-12-DS10
 Custom sizes available on request. Design charges may apply.
 Colors may change and are subject to availability. Refer to website for details or contact your local sales representative.

KAYRA CURVED SCREEN

Kayra Curved Screens are a simple but elegant way to divide and soundproof open plan spaces. Available in a range of finishes and in a full curve or wave shape, they work in any interior space. Multiple Kayra Curved Screens can infinitely connect together to make a wide variety of shapes and sizes that create custom acoustical meeting spaces!

SCAN FOR MORE INFO



CODE **K A Y - X X X - X X - X X - X X - X X - X X X X**
 PRODUCT SHAPE CODE DEPTH WIDTH HEIGHT THICKNESS COLOR

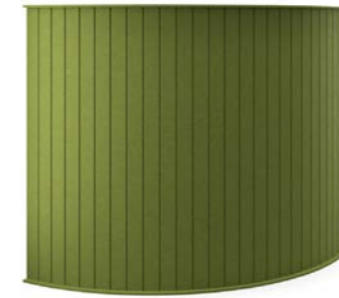

C SHAPE
CODE CCC



S SHAPE
CODE SSS

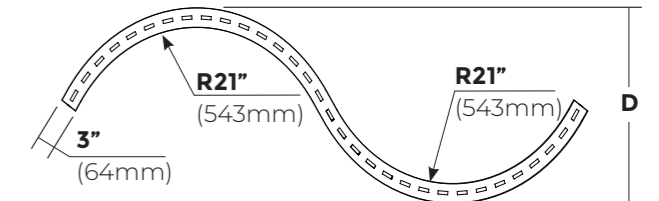
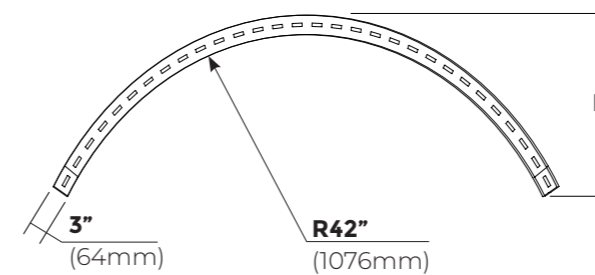
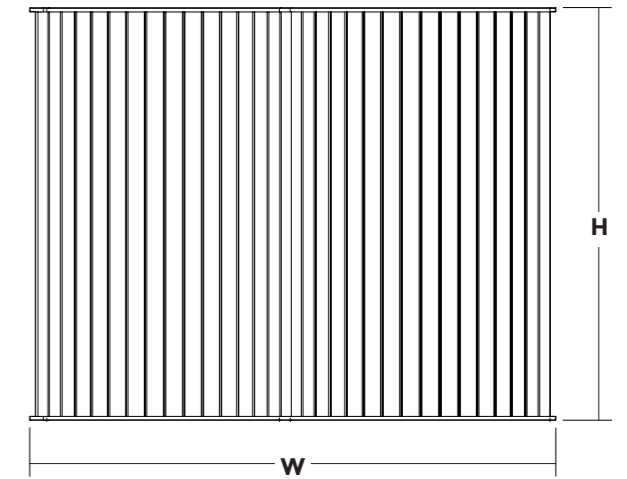
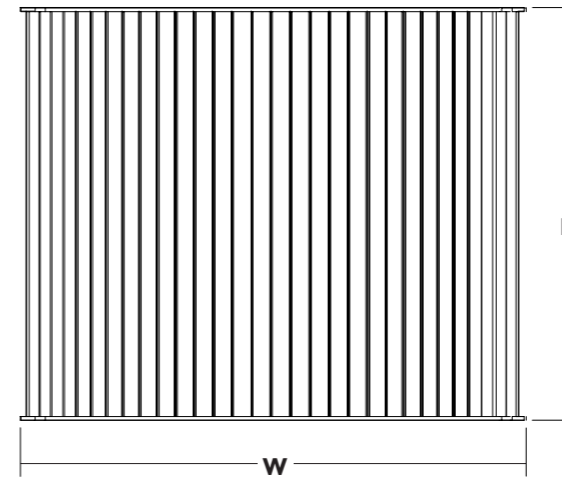

CODE	DEPTH (D)	WIDTH (W)	HEIGHT (H)	THICKNESS
KAY-CCC-23-77-53-12-XXXX	23" (584mm)	77" (1955mm)	53" (1346mm)	1/2" (12mm)
KAY-SSS-25-81-53-12-XXXX	25" (609mm)	81" (2057mm)	53" (1346mm)	1/2" (12mm)
KAY-CCC-23-77-73-12-XXXX	23" (584mm)	77" (1955mm)	73" (1850mm)	1/2" (12mm)
KAY-SSS-25-81-73-12-XXXX	25" (609mm)	81" (2057mm)	73" (1850mm)	1/2" (12mm)

All dimensions indicated are nominal

COLOR CODE

DESERT SAND CODE DS10	BRICK RED CODE BR34	CHARCOAL GRAY CODE CG06	SILVER GRAY CODE SG04	MOSS GREEN CODE MG10	ROYAL BLUE CODE RB08

Please add color code on all orders: example PYR-24-69-PW-WB-12-DS10
 Custom sizes available on request. Design charges may apply.
 Colors may change and are subject to availability. Refer to website for details or contact your local sales representative.

HARDWARE

DESK AND MODESTY SCREEN BRACKETS

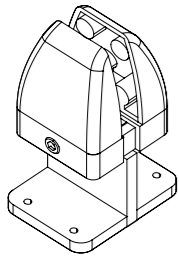

PJ101
Compatible with material 1/2" (12mm) or 11/16" (18mm) thick. Surface thickness limited to 1" (25mm) - 1 1/4" (70mm)

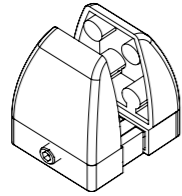

PJ3
Compatible with material 1/2" (12mm), or 11/16" (18mm) thick.

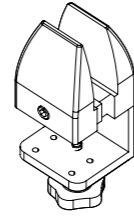

PJ4
Compatible with material 1/2" (12mm) or 11/16" (18mm) thick. Surface thickness limited to 1" (25mm) - 1 1/4" (70mm)

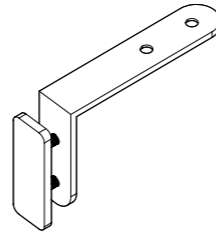

PJ 15/17
Compatible with material 1/2" (12mm) and 11/16" (18mm)

WORK ZONE DIVIDER CLAMPS AND SUSPENSION KIT

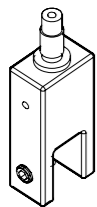

CBG-C
Compatible with Upper and Lower Suspension Housing. Intended for use with 3/8" (9mm) and 1/2" (12mm) material. Specify placement on material for use with larger thicknesses.

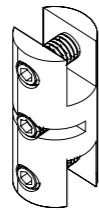

CVD
Clamp intended to connect two 3/8" (9mm) or 1/2" (12mm) material. Specify placement on material.



CF6-01
Ceiling fitting to be used with mechanical fastener. Includes 13'-1 1/2" (4000mm) of cable. Brass Locator accepts #8 Screws, not included.



Work Zone Divider Modular, with custom radius corner detail system



DESIGN
DRIVEN
ACOUSTICS

UNITED STATES

Ayrsonics Mid West LLC

170 Prairie Lake Rd
East Dundee, IL 60118
1-800-517-0686
sales@mw.ayrsonics.com

Ayrsonics Southwest LLC

1700 1st Street
San Fernando, CA 91340
213-833-9700
sales@sw.ayrsonics.com

Ayrsonics New England LLC

32 Hampshire Rd
Salem, NH 03079
603-824-9338 ext. 3001
603-327-4349
sales@ne.ayrsonics.com

CANADA

Ayrsonics Inc - Ontario

825 Trillium Drive
Kitchener, Ontario N2R 1J9
1-844-441-1122
sales@ayrsonics.com

Ayrsonics Inc - Alberta

#9112 – 52nd St. S.E.
Calgary, Alberta T2C 5A9
1-844-441-1122
sales@ayrsonics.com

EzoBord Corporate Office

6845 Rexwood Road,
Unit 7 Mississauga,
ON L4V 1S5 Canada
+1 416 665 3571
info@ezobord.com

CENTRAL & LATIN AMERICA

EzoBord Costa Rica SRL

100 Sur 25 Oeste Recope
Bodega #18 Ochomogo, Cartago
+506 8842 4613
info-latam@ezobord.com

EzoBord - LATAM

Buenos Aires, Argentina
+54 9 11 5657 1793
info-latam@ezobord.com

UNITED KINGDOM

EzoBord UK Ltd

Unit 20 Westwood Business Park
Margate, Kent. CT9 4JJ
+44 1843 264027
sales@ezobord.co.uk

IRELAND

EzoBord Ireland

Unit 523, Greenogue Business Park
Rathcoole, Co. Dublin D24 RY89
+353 (0)1 443 3599
sales@ezobord.ie

FOLLOW US

