



EZO
B O R D

DESIGN
DRIVEN
ACOUSTICS

PRICE GUIDE (USD)
2022

Ayrsonics
Design Driven Acoustics

PRICE & SPECIFICATION GUIDE

New and improved, this specification guide is your reference for the most important product information.

All dimensions are listed widest point to tallest point(See Below). Dimensions are nominal. Some sizes such as cell density vary by overall unit width and length. For more details on the size and shape of a product, technical shop drawings are provided at order point and available upon request. For more detail, please contact your local sales representative.

Listed SKUs within this catalogue do not include EzoBord color information. Ensure inclusion of color selected when ordering to avoid delays.

All products are priced as listed, and without suspension hardware. Recommendations on best hardware for application are available through your local sales representative. Some products may have variation in manufacturing based on mounting or suspension. Specify intended application with order to ensure compatibility.

Custom patterns, shapes, and sizes are always welcome. Please contact customer service for accurate pricing on custom products.

INDEX

CEILING

BAFFLE CLOUDS	4
CEILING BAFFLE	7
RAIL LED	8
RAIL ACOUSTIC	9
GRID CANOPY.....	10
ACOUSTICAL NET	14
GEO CLOUD	16
FULL SHEET CLOUD.....	18
SUMMIT CLOUD	20

WALLS

GEO TILE	22
V-NOTCH SHEET	26
WORK ZONE DIVIDER	28
EZO ON EZO	30
EZO PRINT	32
PANELS & SHEETS.....	34

OFFICE

DESK DIVIDERS	36
HOODY	40
OBI - MOBILE WHITE BOARD SYSTEM	42
SUSPENDED OFFICE	44

HARDWARE	46
----------------	----

SPECIFICATIONS	48
----------------------	----

CONDITION OF SALE, RETURN POLICY & WARRANTY FOR AYRSONICS INC.....	50
--	----

BAFFLE CLOUD

EzoBord Baffle Clouds are a stylish addition to any ceiling, easy to install, and can be customized through the use of wide array of standard EzoBord colors.

A new generation of ceiling baffles - sound dampening, free-hanging and designed for style. Stylish EzoBord Baffle Clouds are a series of sound absorbing suspended panels that redefine interior open spaces.



CODE BFC - XXX - XXXXX - XXXX
PRODUCT SHAPE WIDTH LENGTH HEIGHT CELL DENSITY THICKNESS

STANDARD SHAPES
CUSTOM SHAPES AVAILABLE

AALTO
CODE AAL

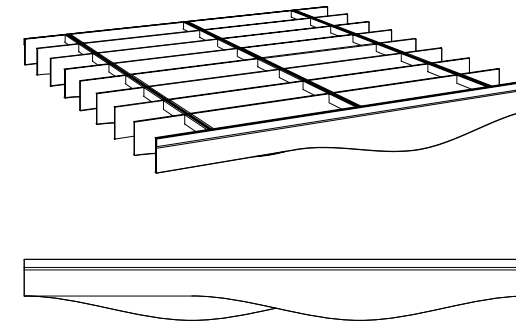

VELDI
CODE VEL

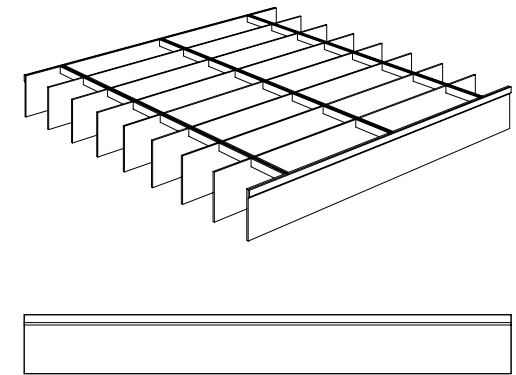

VESI
CODE VES

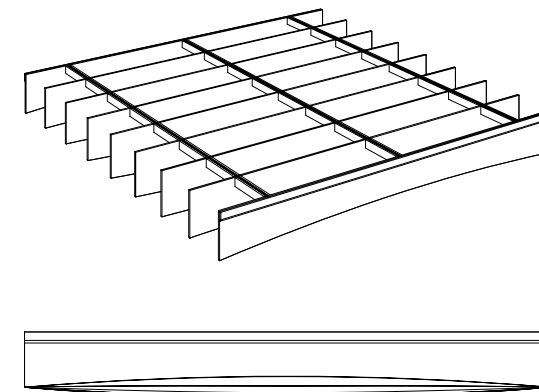

LUNA ROUND
CODE LUR

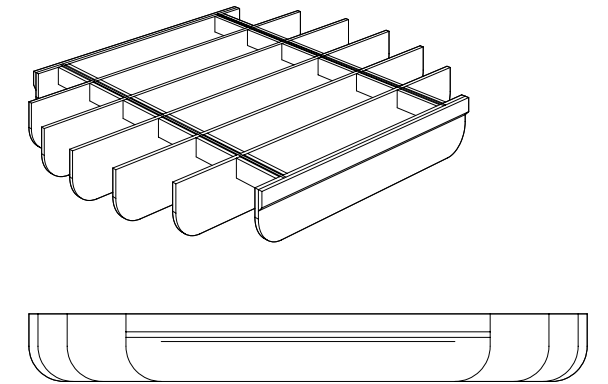

LUNA SQUARE
CODE LUS

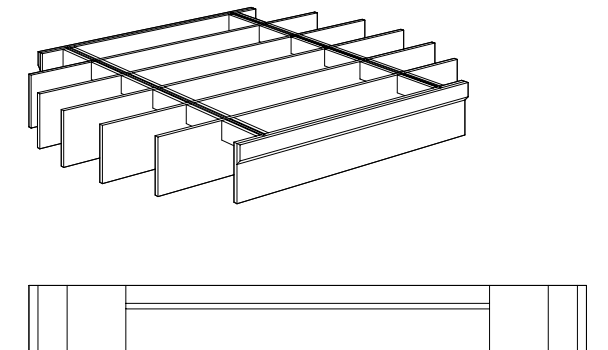

BAFFLE CLOUD

CODE BFC - XXX - XXXXX - XXXX
 PRODUCT SHAPE WIDTH LENGTH HEIGHT CELL DENSITY THICKNESS

CODE	SHAPE	HEIGHT	CELL DENSITY	THICKNESS	PRICE
BFC-AAL-XXXX08-0809	AALTO	8"	8"	9mm (3/8")	\$ 70 /SQFT
BFC-AAL-XXXX08-0812	AALTO	8"	8"	12mm (1/2")	\$ 90 /SQFT
BFC-AAL-XXXX12-0809	AALTO	11.5"	8"	9mm (3/8")	\$ 80 /SQFT
BFC-AAL-XXXX12-0812	AALTO	11.5"	8"	12mm (1/2")	\$ 103 /SQFT
BFC-AAL-XXXX12-1209	AALTO	11.5"	12"	9mm (3/8")	\$ 57 /SQFT
BFC-AAL-XXXX12-1212	AALTO	11.5"	12"	12mm (1/2")	\$ 72 /SQFT
BFC-LUR-XXXX08-0809	LUNA ROUND	8"	8"	9mm (3/8")	\$ 63 /SQFT
BFC-LUR-XXXX08-0812	LUNA ROUND	8"	8"	12mm (1/2")	\$ 82 /SQFT
BFC-LUR-XXXX12-0809	LUNA ROUND	11.5"	8"	9mm (3/8")	\$ 72 /SQFT
BFC-LUR-XXXX12-0812	LUNA ROUND	11.5"	8"	12mm (1/2")	\$ 94 /SQFT
BFC-LUR-XXXX12-1209	LUNA ROUND	11.5"	12"	9mm (3/8")	\$ 52 /SQFT
BFC-LUR-XXXX12-1212	LUNA ROUND	11.5"	12"	12mm (1/2")	\$ 66 /SQFT
BFC-LUS-XXXX08-0809	LUNA SQUARE	8"	8"	9mm (3/8")	\$ 63 /SQFT
BFC-LUS-XXXX08-0812	LUNA SQUARE	8"	8"	12mm (1/2")	\$ 82 /SQFT
BFC-LUS-XXXX12-0809	LUNA SQUARE	11.5"	8"	9mm (3/8")	\$ 74 /SQFT
BFC-LUS-XXXX12-0812	LUNA SQUARE	11.5"	8"	12mm (1/2")	\$ 94 /SQFT
BFC-LUS-XXXX12-1209	LUNA SQUARE	11.5"	12"	9mm (3/8")	\$ 52 /SQFT
BFC-LUS-XXXX12-1212	LUNA SQUARE	11.5"	12"	12mm (1/2")	\$ 66 /SQFT
BFC-VEL-XXXX08-0809	VELDI	8"	8"	9mm (3/8")	\$ 63 /SQFT
BFC-VEL-XXXX08-0812	VELDI	8"	8"	12mm (1/2")	\$ 82 /SQFT
BFC-VEL-XXXX12-0809	VELDI	11.5"	8"	9mm (3/8")	\$ 72 /SQFT
BFC-VEL-XXXX12-0812	VELDI	11.5"	8"	12mm (1/2")	\$ 94 /SQFT
BFC-VEL-XXXX12-1209	VELDI	11.5"	12"	9mm (3/8")	\$ 52 /SQFT
BFC-VEL-XXXX12-1212	VELDI	11.5"	12"	12mm (1/2")	\$ 66 /SQFT
BFC-VES-XXXX08-0809	VESI	8"	8"	9mm (3/8")	\$ 70 /SQFT
BFC-VES-XXXX08-0812	VESI	8"	8"	12mm (1/2")	\$ 90 /SQFT
BFC-VES-XXXX12-0809	VESI	11.5"	8"	9mm (3/8")	\$ 80 /SQFT
BFC-VES-XXXX12-0812	VESI	11.5"	8"	12mm (1/2")	\$ 103 /SQFT
BFC-VES-XXXX12-1209	VESI	11.5"	12"	9mm (3/8")	\$ 57 /SQFT
BFC-VES-XXXX12-1212	VESI	11.5"	12"	12mm (1/2")	\$ 72 /SQFT

INDIVIDUAL BAFFLES

CODE BFC - XXX - XXXXX
 PRODUCT SHAPE LENGTH THICKNESS HEIGHT

REC
CODE REC

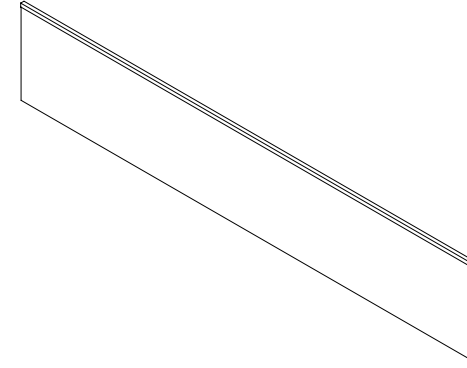

FIL
CODE FIL

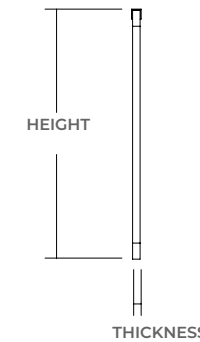
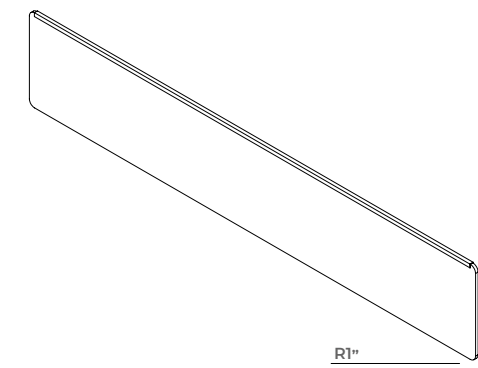

CODE	SHAPE	HEIGHT	THICKNESS	PRICE
BAF-XXX-XX0812	REC / FIL	7.5"*	12mm (1/2")	\$ 53 /LINEAR FT
BAF-XXX-XX0818	REC / FIL	7.5"*	18mm (3/4")	\$ 69 /LINEAR FT
BAF-XXX-XX0824	REC / FIL	7.5"*	24mm (1")	\$ 77 /LINEAR FT
BAF-XXX-XX1212	REC / FIL	11.5"*	12mm (1/2")	\$ 63 /LINEAR FT
BAF-XXX-XX1218	REC / FIL	11.5"*	18mm (3/4")	\$ 87 /LINEAR FT
BAF-XXX-XX1224	REC / FIL	11.5"*	24mm (1")	\$ 97 /LINEAR FT
BAF-XXX-XX1612	REC / FIL	15.5"*	12mm (1/2")	\$ 72 /LINEAR FT
BAF-XXX-XX1618	REC / FIL	15.5"*	18mm (3/4")	\$ 104 /LINEAR FT
BAF-XXX-XX1624	REC / FIL	15.5"*	24mm (1")	\$ 118 /LINEAR FT

Custom sizes available upon request

RAIL LED

CODE B X B - L I T - X X X X 0 3
 PRODUCT WIDTH THICKNESS HEIGHT

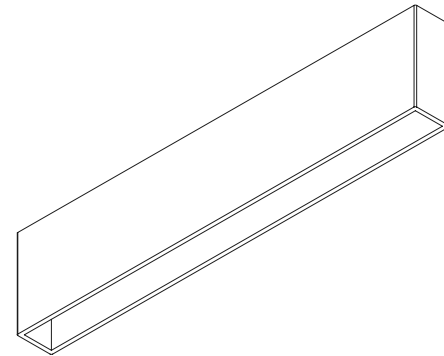

With Rail we are going beyond illumination for interior spaces. True to our acoustic roots, we incorporate the performance of EzoBord material to LED technology providing a synergistic relation between acoustics and lighting as a solution to high-end noise levels, reverberation and poor lighting issues common to open spaces.



DIMENSIONS

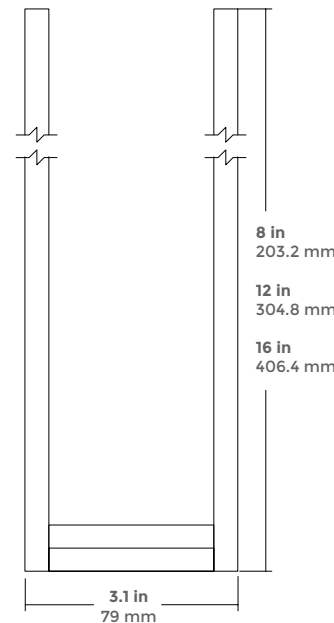
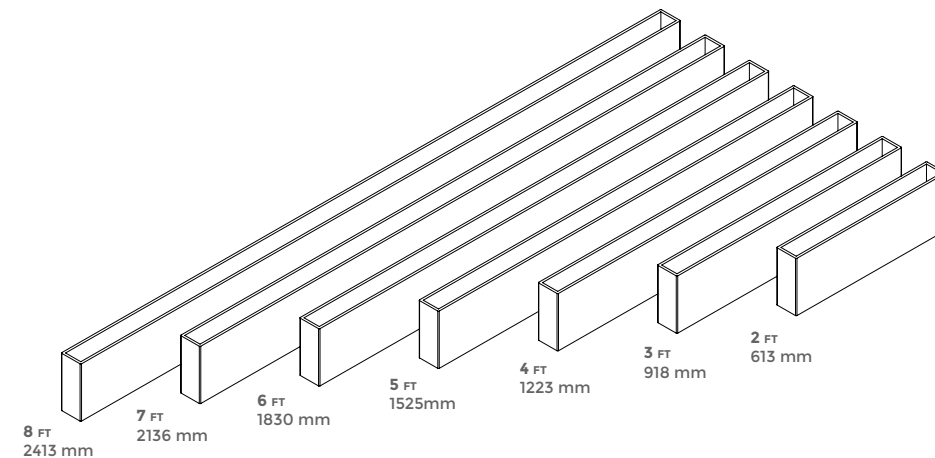

Hardware not included.
Options listed in hardware guide pages 46-47

RAIL ACOUSTIC

CODE B X B - B O X - X X X X 0 3
 PRODUCT WIDTH THICKNESS HEIGHT

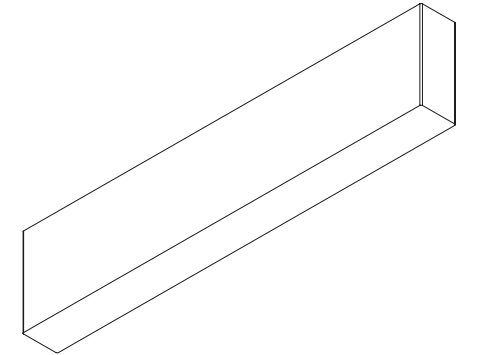

Rail Unlit is a great solution to control spaces with high indexes of reverberation. Rail Unlit shape optimizes the NRC performance of very room. This product can be used in hospitality and office spaces.

Rail Unlit can be specified in various lengths ranging from 2 feet to 8 feet, and three heights (8,12,16) inches, giving you the possibility to create unique baffle arrays.

In terms of finishes and colors we are introducing our new woodgrain selection (see colors-finishes).



CODE	HEIGHT	THICKNESS	COLOR	PRICE
BXB-LIT-XX0803	8"(203mm)	3.1"(79mm)	15 (9mm color)	\$ 262 /LINEAR FT
BXB-LIT-XX0803	8"(203mm)	3.1"(79mm)	CUSTOM PRINT	\$ 311 /LINEAR FT
BXB-LIT-XX1203	12"(305mm)	3.1"(79mm)	15 (9mm color)	\$ 281 /LINEAR FT
BXB-LIT-XX1203	12"(305mm)	3.1"(79mm)	CUSTOM PRINT	\$ 378 /LINEAR FT
BXB-LIT-XX1603	16"(406mm)	3.1"(79mm)	15 (9mm color)	\$ 300 /LINEAR FT
BXB-LIT-XX1603	16"(406mm)	3.1"(79mm)	CUSTOM PRINT	\$ 396 /LINEAR FT
BXB-BOX-XX0803	8"(203mm)	3.1"(79mm)	15 (9mm color)	\$ 116 /LINEAR FT
BXB-BOX-XX0803	8"(203mm)	3.1"(79mm)	CUSTOM PRINT	\$ 164 /LINEAR FT
BXB-BOX-XX1203	12"(305mm)	3.1"(79mm)	15 (9mm color)	\$ 186 /LINEAR FT
BXB-BOX-XX1203	12"(305mm)	3.1"(79mm)	CUSTOM PRINT	\$ 283 /LINEAR FT
BXB-BOX-XX1603	16"(406mm)	3.1"(79mm)	15 (9mm color)	\$ 205 /LINEAR FT
BXB-BOX-XX1603	16"(406mm)	3.1"(79mm)	CUSTOM PRINT	\$ 301 /LINEAR FT

Please contact your local sales representative for more information.
Note that all dimensions are nominal, supplier reserves the right to adjust sizing without prior notification.

GRID CANOPY

Suspended EzoBord Grid Canopies bring room acoustics to an entirely new level. Control room reverberation in both monotone and duotone color options.

Ceiling mounted for both sound absorption and aesthetic purposes, EzoBord Grid Canopies reduce echo and unwanted noise in boardrooms, meeting areas, open plan offices or a variety of public spaces. Grid Canopies assemble in just a few minutes, are super light weight and easy to suspend from any ceiling with several suspension hardware options to choose from.

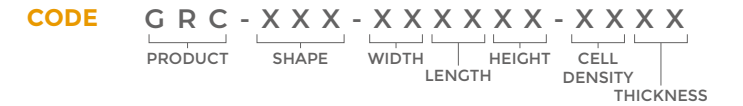
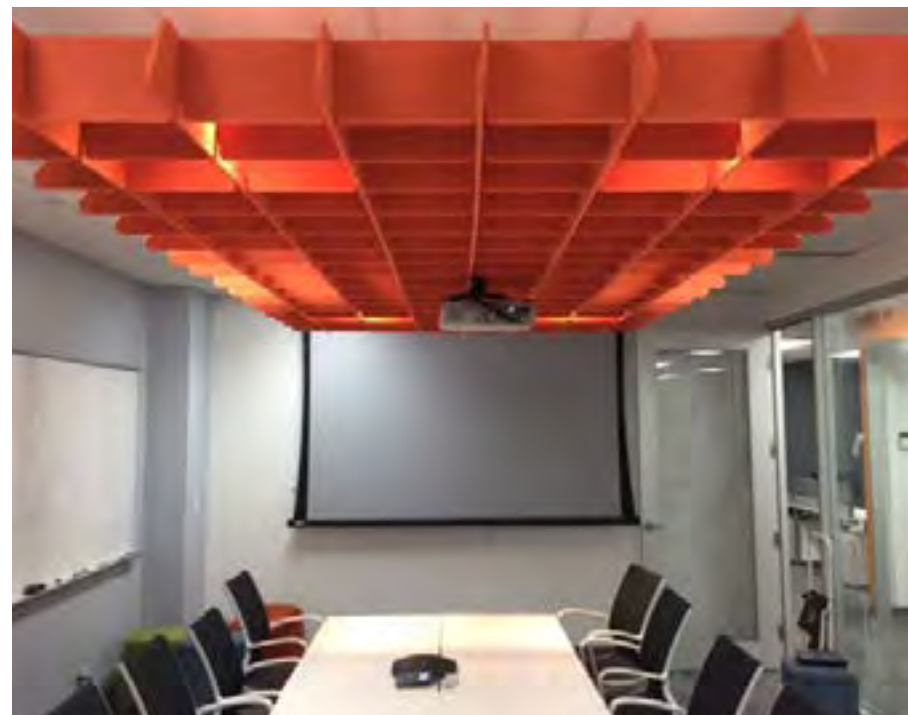
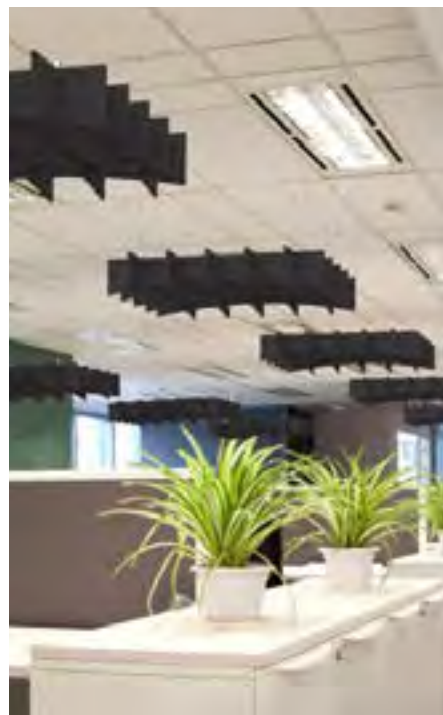

STANDARD SHAPES

CITE
CODE CIT

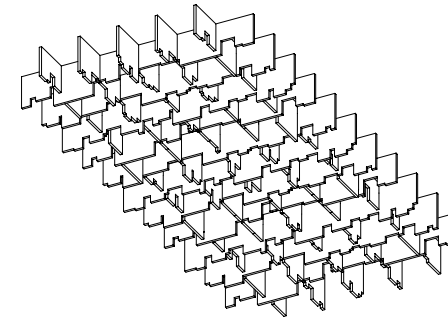

KUPI
CODE KUP

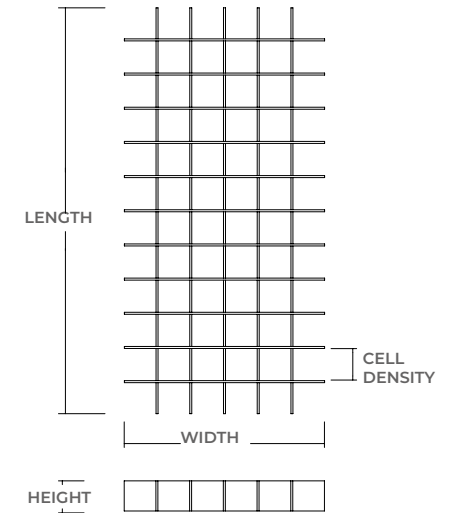
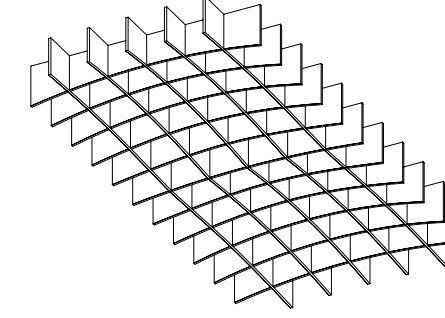

CODE	SHAPE	HEIGHT	CELL DENSITY	THICKNESS	COLORS	PRICE
GRC-CIT-XXXX06-0809	CITE	5.5"	8"	9mm (3/8")	15	\$ 68 /SQFT
GRC-CIT-XXXX06-0812	CITE	5.5"	8"	12mm (1/2")	15	\$ 88 /SQFT
GRC-CIT-XXXX06-1209	CITE	5.5"	12"	9mm (3/8")	15	\$ 47 /SQFT
GRC-CIT-XXXX06-1212	CITE	5.5"	12"	12mm (1/2")	15	\$ 61 /SQFT
GRC-CIT-XXXX10-0809	CITE	10"	8"	9mm (3/8")	15	\$ 102 /SQFT
GRC-CIT-XXXX10-0812	CITE	10"	8"	12mm (1/2")	15	\$ 132 /SQFT
GRC-CIT-XXXX10-1209	CITE	10"	12"	9mm (3/8")	15	\$ 60 /SQFT
GRC-CIT-XXXX10-1212	CITE	10"	12"	12mm (1/2")	15	\$ 78 /SQFT
GRC-KUP-XXXX06-0809	KUPI	5.5"	8"	9mm (3/8")	15	\$ 85 /SQFT
GRC-KUP-XXXX06-0812	KUPI	5.5"	8"	12mm (1/2")	15	\$ 110 /SQFT
GRC-KUP-XXXX06-1209	KUPI	5.5"	12"	9mm (3/8")	15	\$ 60 /SQFT
GRC-KUP-XXXX06-1212	KUPI	5.5"	12"	12mm (1/2")	15	\$ 78 /SQFT
GRC-KUP-XXXX10-0809	KUPI	10"	8"	9mm (3/8")	15	\$ 113 /SQFT
GRC-KUP-XXXX10-0812	KUPI	10"	8"	12mm (1/2")	15	\$ 147 /SQFT
GRC-KUP-XXXX10-1209	KUPI	10"	12"	9mm (3/8")	15	\$ 79 /SQFT
GRC-KUP-XXXX10-1212	KUPI	10"	12"	12mm (1/2")	15	\$ 103 /SQFT

Custom sizes available upon request

GRID CANOPY

CODE GRC - XXX - XXXXX - XXXX
PRODUCT SHAPE WIDTH LENGTH HEIGHT CELL DENSITY THICKNESS

STANDARD SHAPES

RECTANGLE

CODE REC

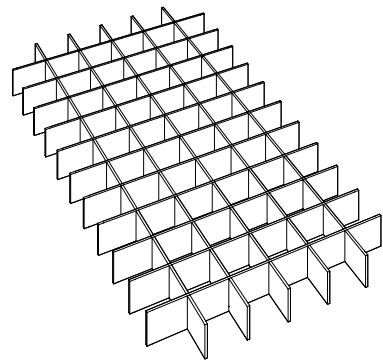

TAPERED

CODE TAP

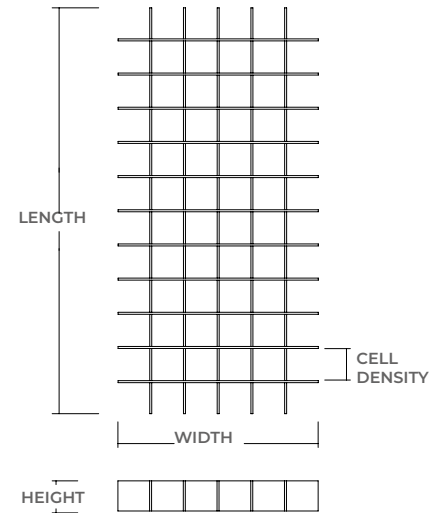
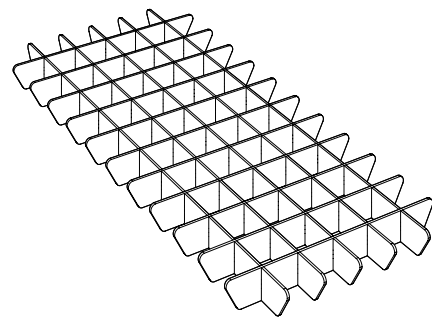

CODE	SHAPE	HEIGHT	CELL DENSITY	THICKNESS	COLORS	PRICE
GRC-REC-XXXX06-0809	RECTANGULAR	5.5"	8"	9mm (3/8")	15	\$ 56 /SQFT
GRC-REC-XXXX06-0812	RECTANGULAR	5.5"	8"	12mm (1/2")	15	\$ 73 /SQFT
GRC-REC-XXXX06-1209	RECTANGULAR	5.5"	12"	9mm (3/8")	15	\$ 40 /SQFT
GRC-REC-XXXX06-1212	RECTANGULAR	5.5"	12"	12mm (1/2")	15	\$ 52 /SQFT
GRC-REC-XXXX10-0809	RECTANGULAR	10"	8"	9mm (3/8")	15	\$ 85 /SQFT
GRC-REC-XXXX10-0812	RECTANGULAR	10"	8"	12mm (1/2")	15	\$ 110 /SQFT
GRC-REC-XXXX10-1209	RECTANGULAR	10"	12"	9mm (3/8")	15	\$ 59 /SQFT
GRC-REC-XXXX10-1212	RECTANGULAR	10"	12"	12mm (1/2")	15	\$ 77 /SQFT
GRC-TAP-XXXX06-0809	TAPERED	5.5"	8"	9mm (3/8")	15	\$ 56 /SQFT
GRC-TAP-XXXX06-0812	TAPERED	5.5"	8"	12mm (1/2")	15	\$ 73 /SQFT
GRC-TAP-XXXX06-1209	TAPERED	5.5"	12"	9mm (3/8")	15	\$ 40 /SQFT
GRC-TAP-XXXX06-1212	TAPERED	5.5"	12"	12mm (1/2")	15	\$ 52 /SQFT
GRC-TAP-XXXX10-0809	TAPERED	10"	8"	9mm (3/8")	15	\$ 85 /SQFT
GRC-TAP-XXXX10-0812	TAPERED	10"	8"	12mm (1/2")	15	\$ 110 /SQFT
GRC-TAP-XXXX10-1209	TAPERED	10"	12"	9mm (3/8")	15	\$ 59 /SQFT
GRC-TAP-XXXX10-1212	TAPERED	10"	12"	12mm (1/2")	15	\$ 77 /SQFT

Custom sizes available upon request

STANDARD SHAPES

WAFFLE

CODE WAF

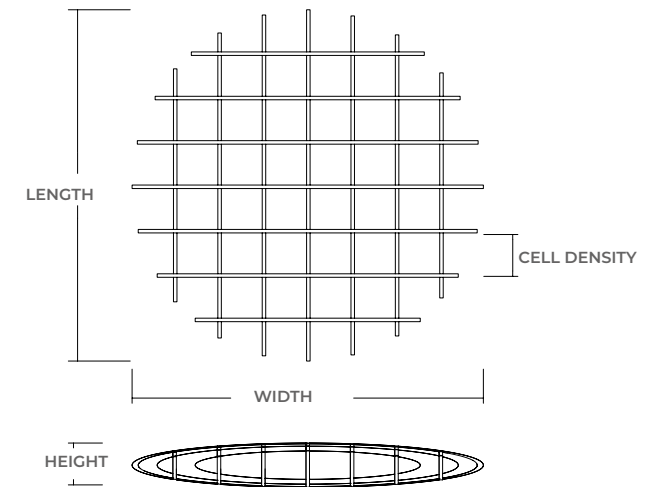
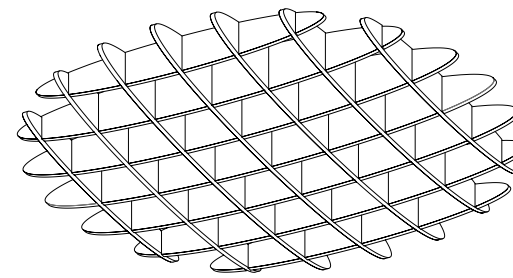

CODE	SHAPE	HEIGHT	CELL DENSITY	THICKNESS	COLORS	PRICE
GRC-WAF-XXXX06-0809	WAFFLE	5.5"	8"	9mm (3/8")	15	\$ 56 /SQFT
GRC-WAF-XXXX06-0812	WAFFLE	5.5"	8"	12mm (1/2")	15	\$ 73 /SQFT
GRC-WAF-XXXX06-1209	WAFFLE	5.5"	12"	9mm (3/8")	15	\$ 40 /SQFT
GRC-WAF-XXXX06-1212	WAFFLE	5.5"	12"	12mm (1/2")	15	\$ 52 /SQFT
GRC-WAF-XXXX10-0809	WAFFLE	10"	8"	9mm (3/8")	15	\$ 85 /SQFT
GRC-WAF-XXXX10-0812	WAFFLE	10"	8"	12mm (1/2")	15	\$ 110 /SQFT
GRC-WAF-XXXX10-1209	WAFFLE	10"	12"	9mm (3/8")	15	\$ 59 /SQFT
GRC-WAF-XXXX10-1212	WAFFLE	10"	12"	12mm (1/2")	15	\$ 77 /SQFT

Custom sizes available upon request

ACOUSTICAL NET

EzoBord Acoustical Net canopies are completely customizable, add flow, color and acoustical balance to open ceiling environments while reducing unwanted noise.

A new generation surface material that absorbs noise and is fully customizable.

Make a statement with EzoBord Acoustical Nets by adding atmosphere and visual interest to offices, restaurants, and other public spaces, while depending on EzoBord's noise reduction capabilities to establish a creative and acoustically effective ceiling scape.

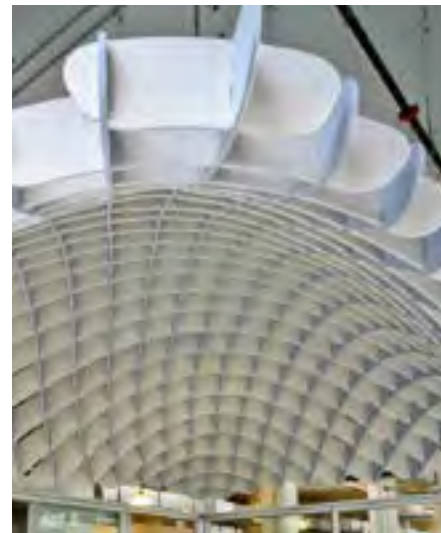

CODE	SHAPE	HEIGHT	CELL DENSITY	THICKNESS	COLORS	PRICE
NET-RUL-XXXX12-0809	RULLA	11.5"*	8"	9mm (3/8")	15	\$ 99 /SQFT
NET-RUL-XXXX12-0812	RULLA	11.5"*	8"	12mm (1/2")	15	\$ 137 /SQFT
NET-RUL-XXXX18-0809	RULLA	18"***	8"	9mm (3/8")	15	\$ 138 /SQFT
NET-RUL-XXXX18-0812	RULLA	18"***	8"	12mm (1/2")	15	\$ 187 /SQFT
NET-KRO-XXXX12-0809	KROMME	11.5"*	8"	9mm (3/8")	15	\$ 99 /SQFT
NET-KRO-XXXX12-0812	KROMME	11.5"*	8"	12mm (1/2")	15	\$ 137 /SQFT
NET-KRO-XXXX18-0809	KROMME	18"***	8"	9mm (3/8")	15	\$ 138 /SQFT
NET-KRO-XXXX18-0812	KROMME	18"***	8"	12mm (1/2")	15	\$ 187 /SQFT
NET-GOL-XXXX12-0809	GOLF	11.5"*	8"	9mm (3/8")	15	\$ 99 /SQFT
NET-GOL-XXXX12-0812	GOLF	11.5"*	8"	12mm (1/2")	15	\$ 137 /SQFT
NET-GOL-XXXX18-0809	GOLF	18"***	8"	9mm (3/8")	15	\$ 138 /SQFT
NET-GOL-XXXX18-0812	GOLF	18"***	8"	12mm (1/2")	15	\$ 187 /SQFT

Custom sizes available upon request

*6-12" Undulation

**6-18" Undulation

CODE NET - XXX - XXXXX - XXXX
PRODUCT SHAPE WIDTH LENGTH HEIGHT CELL DENSITY THICKNESS

STANDARD SHAPES
 CUSTOM SHAPES AVAILABLE

RULLA
 CODE RUL

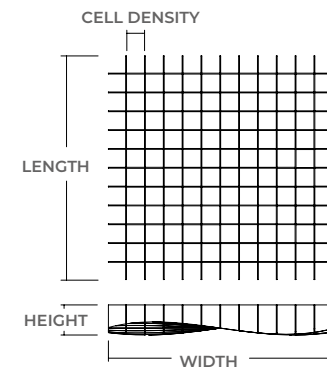
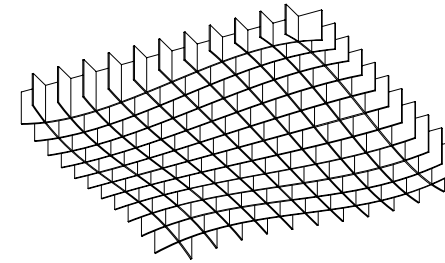

KROMME
 CODE KRO

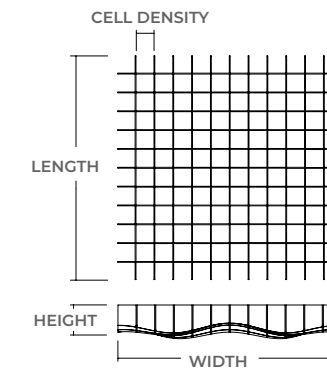
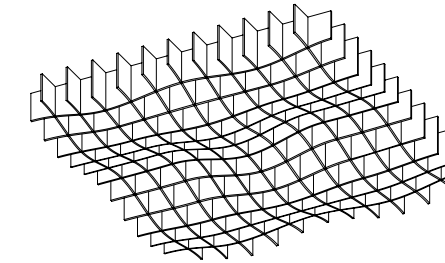

GOLF
 CODE GOL

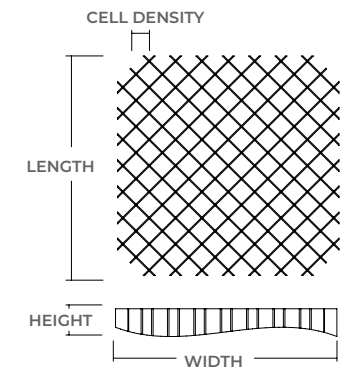
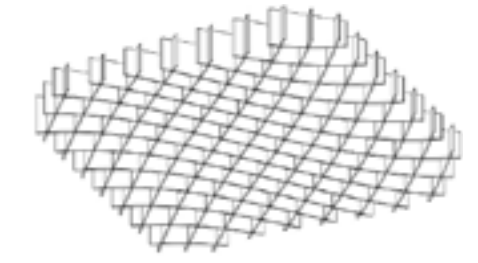

CUSTOM
 CODE CUS

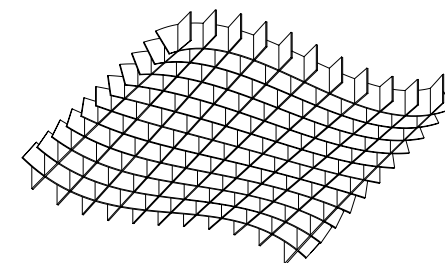

Pricing for custom nets as quoted. Design limitations in addition to those listed may apply. Custom nets available with undulation bottom or top and bottom as well as irregular shapes.

TYPICAL DESIGN LIMITATIONS NOTED:

- Minimum panel height at any point within the unit is 6"; maximum 24", pending overall design.
- EzoBord may recommend 12mm (1/2") thick material specifically to accommodate design and engineering requirements.
- Cell density affects structural integrity and suspension point availability, as well as price. Some designs may require specific cell density. Standard cell density is 8" and custom cell densities may be available depending on net design.

Accommodation for HVAC and other ceiling details is possible and requires exact locations and dimensions. It is strongly recommended to confirm building code restrictions within your area. EzoBord and its distributors assumes no liability for inaccurate drawings or non compliance of local building code.

GEO CLOUD

EzoBord Geo Clouds provide an elegant addition to any open area and can be customized using different geometric shapes and a wide array of standard colors.

Geo Clouds are available in a wide variety of colors, profiles and shapes with custom shapes and prints also available to fully customize to your installation. Geo Clouds are adjustable to various heights and angles and can be installed from deck, ceilings, drywall, standard T bar suspension systems.

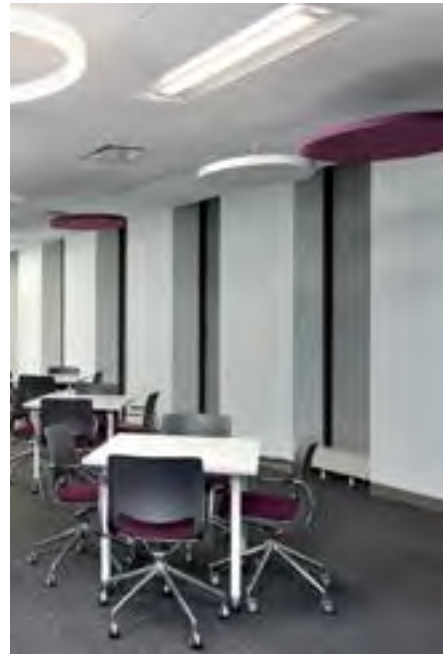

CODE CLD - XXX - XXX XXXX
PRODUCT SHAPE WIDTH LENGTH

STANDARD SHAPES SMALL SIZE

CIRCLE
 CODE CIR
 WIDTH 31" (787MM)
 LENGTH 31" (787MM)
 Available in 1" height only

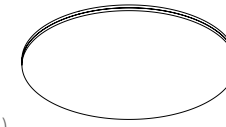

DIAMOND
 CODE DIA
 WIDTH 31" (787.4mm)
 LENGTH 17.9" (454.66mm)

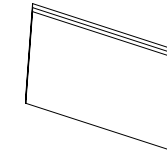

HEZAGON
 CODE HEX
 WIDTH 31" (787.4mm)
 LENGTH 26.8" (680.72mm)

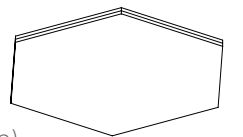

SQUARE
 CODE SQR
 WIDTH 31" (787.4mm)
 LENGTH 31" (787.4mm)

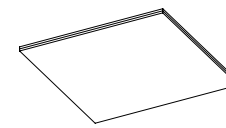

TRAPEZOID
 CODE TRA
 WIDTH 31" (787.4mm)
 LENGTH 13.42" (340.87mm)

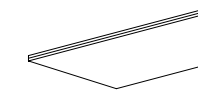

TRIANGLE
 CODE TRI
 WIDTH 31" (787.4mm)
 LENGTH 26.8" (680.72mm)

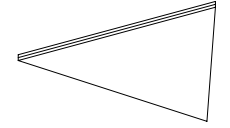

STANDARD SHAPES MEDIUM SIZE

CIRCLE
 CODE CIR
 WIDTH 41" (1041.4mm)
 LENGTH 41" (1041.4mm)
 Available in 1" height only

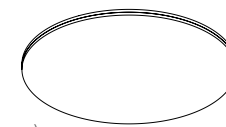

DIAMOND
 CODE DIA
 WIDTH 23.67" (601.23mm)
 LENGTH 41" (1041.4mm)

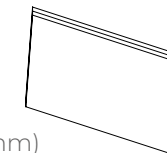

HEZAGON
 CODE HEX
 WIDTH 41" (1041.4mm)
 LENGTH 35.5" (901.7mm)

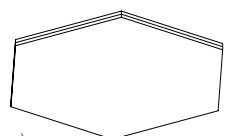

SQUARE
 CODE SQR
 WIDTH 41" (1041.4mm)
 LENGTH 41" (1041.4mm)

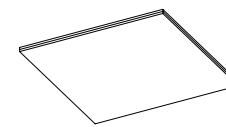

TRAPEZOID
 CODE TRA
 WIDTH 41" (1041.4mm)
 LENGTH 17.75" (450.85mm)

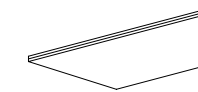

TRIANGLE
 CODE TRI
 WIDTH 41" (1041.4mm)
 LENGTH 35.5" (901.7mm)

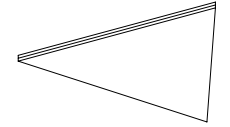

CODE	SIZE	HEIGHT	THICKNESS	COLORS	PRICE
CLD-XXX-XXXXXXXXX	SMALL	48mm (2")	9mm (3/8")	15	\$ 863
CLD-XXX-XXXXXXXXX	SMALL	48mm (2")	12mm (1/2")	15	\$ 987
CLD-XXX-XXXXXXXXX	MEDIUM	48mm (2")	9mm (3/8")	15	\$ 1050
CLD-XXX-XXXXXXXXX	MEDIUM	48mm (2")	12mm (1/2")	15	\$ 1236

Custom sizes available upon request

Please contact your local sales representative for more information. Note that all dimensions are nominal, supplier reserves the right to adjust sizing without prior notification.

FULL SHEET CLOUD

EzoBord Full Sheet Clouds are a stylish addition to any ceiling, easy to install, and can be customized through the use of wide array of standard EzoBord colors.

A new generation of ceiling clouds - sound dampening, free-hanging and designed for style. Stylish EzoBord Full Sheet Clouds are a series of sound absorbing suspended panels that redefine interior open spaces.

Adjustable to various heights and angles, and installed from deck, ceilings, drywall and standard T bar suspension systems.

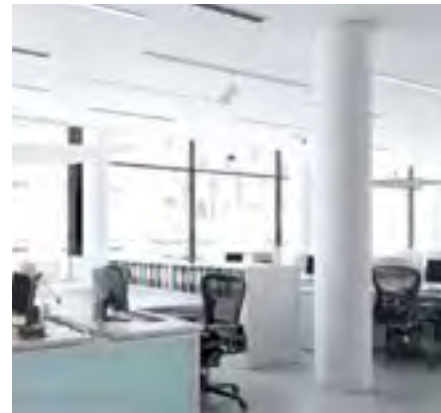

CODE F S C - X X X - X X X X X X - X X
PRODUCT PATTERN WIDTH LENGTH HEIGHT THICKNESS

STANDARD PATTERNS

BAMBOO
CODE BAM

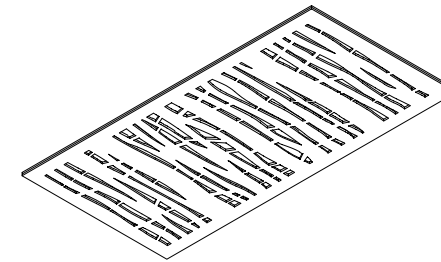

CHEVRON
CODE CHE

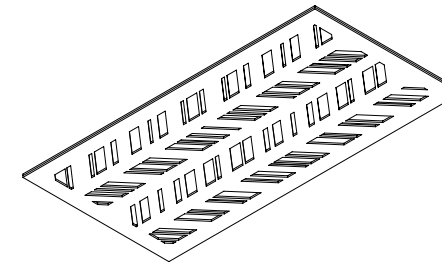

CIRCLE
CODE CIR

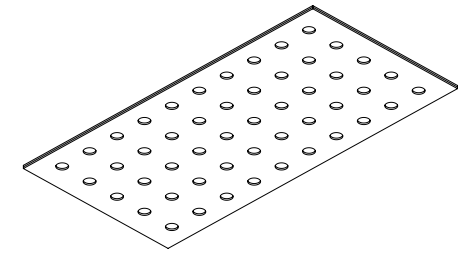

ORBIT
CODE ORB

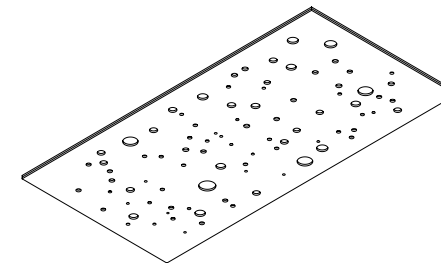

SOLID
CODE SOL

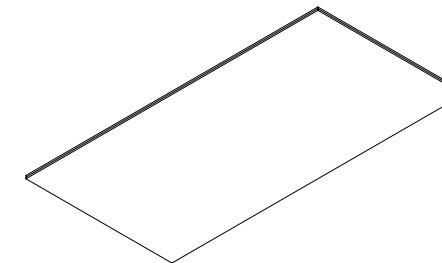

CODE	PATTERN	WIDTH	LENGTH	THICKNESS	PRICE
FSC-BAM-48960112	BAMBOO	47.5"(1207mm)	95" (2413mm)	24mm (1")	\$ 1873
FSC-CHE-48960112	CHEVRON	47.5"(1207mm)	95" (2413mm)	24mm (1")	\$ 1873
FSC-ORB-48960112	ORBIT	47.5"(1207mm)	95" (2413mm)	24mm (1")	\$ 1873
FSC-CIR-48960112	CIRCLE	47.5"(1207mm)	95" (2413mm)	24mm (1")	\$ 1873
FSC-SOL-48960112	SOLID	47.5"(1207mm)	95" (2413mm)	24mm (1")	\$ 1638

Custom sizes available upon request

SUMMIT

Where Geometry meets Peak Performance!

The performance of acoustic panels depends on material and geometry.

EzoBord's three-dimensional Summit baffle system proves that bringing the right combination of materials and design-work can lead to astonishing improvements in acoustic performance.

With an incredible acoustic performance of NRC 1.30 (Type A - direct applied), the Summit system perfectly balances high performance acoustics with high design, high-performance treatment options to the acoustic panel market.



CODE X X X - X X X - X X X X X X - X X
PRODUCT SHAPE WIDTH LENGTH HEIGHT THICKNESS

SHAPES

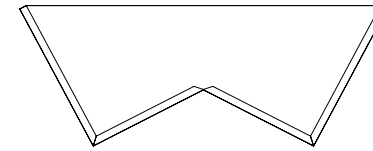

SULPHUR
CODE SUL

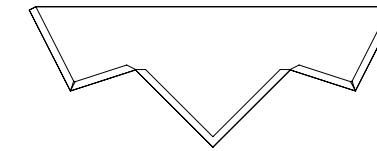

THREE SISTERS
CODE THR

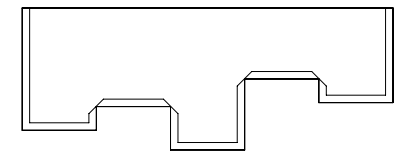

CASTLE
CODE CST

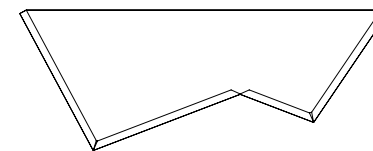

ASSINIBOINE
CODE ASN

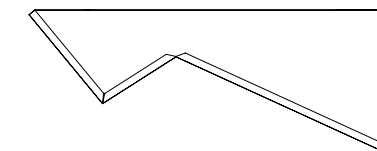

CROWSNEST
CODE CRW

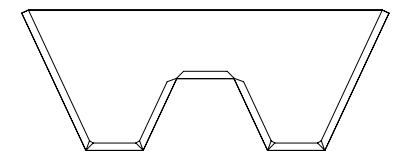

YAMNUSKA
CODE YAM

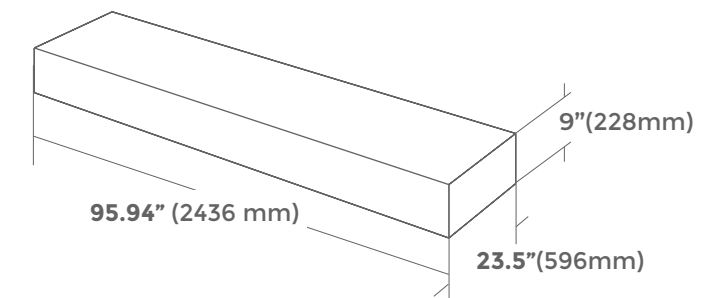

CODE	SHAPE	WIDTH	LENGTH	HEIGHT	STANDARD COLOR PRICE	PRINTED PRICE
SUM-SUL-24960912	SULPHUR	23.5"	96"	9"	\$ 2190	\$ 2690
SUM-THR-24960912	THREE SISTERS	23.5"	96"	9"	\$ 2190	\$ 2690
SUM-CST-24960912	CASTLE	23.5"	96"	9"	\$ 2190	\$ 2690
SUM-ASN-24960912	ASSINIBOINE	23.5"	96"	9"	\$ 2190	\$ 2690
SUM-CRW-24960912	CROWSNEST	23.5"	96"	9"	\$ 2190	\$ 2690
SUM-YAM-24960912	YAMNUSKA	23.5"	96"	9"	\$ 2190	\$ 2690

GEO TILES

EzoBord Geo wall tiles are available in a wide array of shapes and sizes that can be easily installed in endless patterns while controlling room acoustics.

A new generation surface material that both absorbs noise and is fully tackable.

EzoBord Geo Tiles allow for endless patterning and are offered in a wide range of colors to be applied in any combination imaginable. Geo Tiles are super light weight and easy to install with optional pressure sensitive ezoTape on virtually any surface.



CODE G W T - X X X - X X X X X X X
PRODUCT PATTERN CODE WIDTH LENGTH THICKNESS

PATTERNS

BOWTIE
CODE BOW

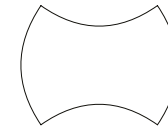

SIZES
 WIDTH 6" (152.4mm)
 LENGTH 4.4" (111.76mm)
 WIDTH 12" (304.8mm)
 LENGTH 8.8" (223.52mm)
 WIDTH 24" (609.6mm)
 LENGTH 17.6" (447.04mm)

Straight edge only

DIAMOND
CODE DIA

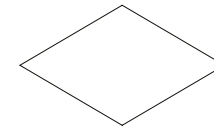

SIZES
 WIDTH 6" (152.4mm)
 LENGTH 3.47" (88.138mm)
 WIDTH 12" (304.8mm)
 LENGTH 6.93" (176.02mm)
 WIDTH 24" (609.6mm)
 LENGTH 13.86" (352.04mm)

ISOCELES
CODE ISO

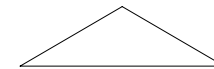

SIZES
 WIDTH 12" (304.8mm)
 LENGTH 3.5" (88.9mm)
 WIDTH 24" (609.6mm)
 LENGTH 7" (177.8mm)

PROPELLER
CODE PRO

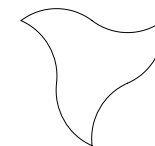

SIZES
 WIDTH 6" (152.4mm)
 LENGTH 5.6" (142.24mm)
 WIDTH 12" (304.8mm)
 LENGTH 11.2" (284.48mm)
 WIDTH 24" (609.6mm)
 LENGTH 22.4" (568.96mm)

Straight edge only

CHEVRON
CODE CHE

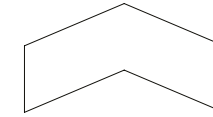

SIZES
 WIDTH 6" (152.4mm)
 LENGTH 3.27" (83.058mm)
 WIDTH 12" (304.8mm)
 LENGTH 6.55" (166.37mm)
 WIDTH 24" (609.6mm)
 LENGTH 13.07" (331.97mm)

FAN
CODE FAN

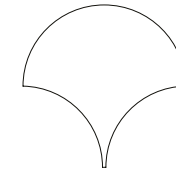

SIZES
 WIDTH 6" (152.4mm)
 LENGTH 6" (152.4mm)
 WIDTH 12" (304.8mm)
 LENGTH 12" (304.8mm)
 WIDTH 24" (609.6mm)
 LENGTH 24" (609.6mm)

Straight edge only

PAISLEY
CODE PAI

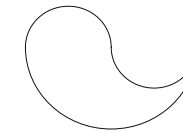

SIZES
 WIDTH 6" (152.4mm)
 LENGTH 4.5" (114.30mm)
 WIDTH 9" (228.6mm)
 LENGTH 12" (304.8mm)
 WIDTH 18" (457.2mm)
 LENGTH 24" (609.6mm)

Straight edge only

PUZZLE
CODE PUZ

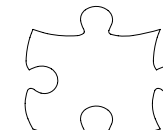

SIZES
 WIDTH 12" (304.8mm)
 LENGTH 9.92" (251.97mm)
 WIDTH 24" (609.6mm)
 LENGTH 19.84" (503.94)

Straight edge only

CIRCLE
CODE CIR

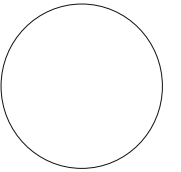

WIDTH 6" (152.4mm)
 LENGTH 6" (152.4mm)
 WIDTH 12" (304.8mm)
 LENGTH 12" (304.8mm)
 WIDTH 24" (609.6mm)
 LENGTH 24" (609.6mm)

Straight edge only

HEXAGON
CODE HEX

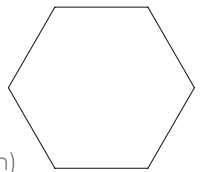

WIDTH 6" (152.4mm)
 LENGTH 5.2" (132.08mm)
 WIDTH 12" (304.8mm)
 LENGTH 10.39" (263.9mm)
 WIDTH 24" (609.6mm)
 LENGTH 20.78" (527.81mm)

PARALLELOGRAM
CODE PAR



SIZES
 WIDTH 12" (304.8mm)
 LENGTH 3" (76.2mm)
 WIDTH 24" (609.6mm)
 LENGTH 6" (152.4mm)

RECTANGLE
CODE REC



SIZES
 WIDTH 5.75" (146.05mm)
 LENGTH 2.88" (73.152mm)
 WIDTH 11.5" (292.1mm)
 LENGTH 5.75" (73.152mm)
 WIDTH 23" (584.2mm)
 LENGTH 11.5" (292.1mm)

GEO TILES

PATTERNS

SQUARE
CODE **SQR**

SIZES

WIDTH 5.75" (146.05mm)
LENGTH 5.75" (146.05mm)

WIDTH 11.5" (292.1mm)
LENGTH 11.5" (292.1mm)

WIDTH 23" (584.2mm)
LENGTH 23" (584.2mm)

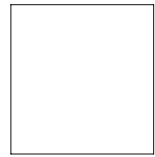

STRIP
CODE **STR**

SIZES

WIDTH 24" (609.6mm)
LENGTH 3" (76.2mm)



TRAPEZOID
CODE **TRA**

SIZES

WIDTH 6" (152.4mm)
LENGTH 2.6" (66.04mm)

WIDTH 12" (304.8mm)
LENGTH 5.2" (132.08mm)

WIDTH 24" (609.6mm)
LENGTH 10.39" (263.91mm)



TRIANGLE
CODE **TRI**

SIZES

WIDTH 6" (152.4mm)
LENGTH 5.2" (132.08mm)

WIDTH 12" (304.8mm)
LENGTH 10.39" (263.9mm)

WIDTH 24" (609.6mm)
LENGTH 20.78" (527.81mm)

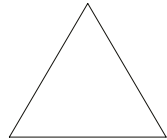

CODE	SIZE	CASE	EDGE	THICKNESS	COLORS	PRICE
GWT-XXX-06XX09	6"	16	STRAIGHT	9mm (3/8")	15	\$ 116
GWT-XXX-06XX12	6"	16	STRAIGHT	12mm (1/2")	15	\$ 134
GWT-XXX-06XX09	6"	16	BEVELED	9mm (3/8")	15	\$ 163
GWT-XXX-06XX12	6"	16	BEVELED	12mm (1/2")	15	\$ 181
GWT-XXX-12XX09	12"	8	STRAIGHT	9mm (3/8")	15	\$ 191
GWT-XXX-12XX12	12"	8	STRAIGHT	12mm (1/2")	15	\$ 347
GWT-XXX-12XX09	12"	8	BEVELED	9mm (3/8")	15	\$ 238
GWT-XXX-12XX12	12"	8	BEVELED	12mm (1/2")	15	\$ 394
GWT-XXX-24XX09	24"	8	STRAIGHT	9mm (3/8")	15	\$ 686
GWT-XXX-24XX12	24"	8	STRAIGHT	12mm (1/2")	15	\$ 965
GWT-XXX-24XX09	24"	8	BEVELED	9mm (3/8")	15	\$ 733
GWT-XXX-24XX12	24"	8	BEVELED	12mm (1/2")	15	\$ 1012

* custom size up to Width 47.5" (1207mm) Length 95" (2413mm)

CODE **GWT** - **XXX** - **XXXXXXX**
PRODUCT PATTERN CODE WIDTH THICKNESS LENGTH

ENHANCED V-NOTCH GEO TILES

SQUARE TARGET
CODE **VTA**

WIDTH 23" (584.2mm)
LENGTH 23" (584.2mm)

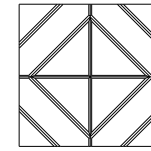

SQUARE STITCH
CODE **VST**

WIDTH 23" (584.2mm)
LENGTH 23" (584.2mm)

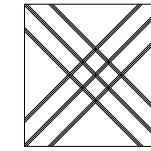

SQUARE RISE
CODE **VRI**

WIDTH 23" (584.2mm)
LENGTH 23" (584.2mm)

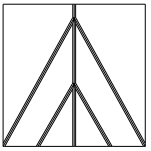

SQUARE PLAID
CODE **VPL**

WIDTH 23" (584.2mm)
LENGTH 23" (584.2mm)

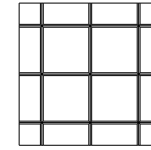

SQUARE PICKET
CODE **VPI**

WIDTH 23" (584.2mm)
LENGTH 23" (584.2mm)

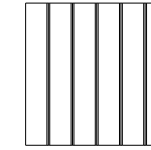

SQUARE CROSS
CODE **VCR**

WIDTH 23" (584.2mm)
LENGTH 23" (584.2mm)

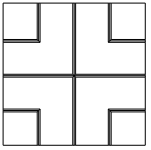

HEXAGON ARROW
CODE **VAR**

WIDTH 23" (584.2mm)
LENGTH 20" (508mm)

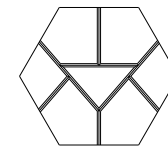

HEXAGON INCEPTION
CODE **VIN**

WIDTH 23" (584.2mm)
LENGTH 20" (508mm)

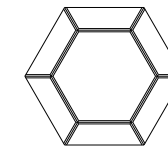

HEXAGON SNOWFALL
CODE **VSN**

WIDTH 23" (584.2mm)
LENGTH 20" (508mm)

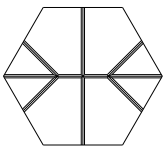

HEXAGON UNION
CODE **VUN**

WIDTH 23" (584.2mm)
LENGTH 20" (508mm)

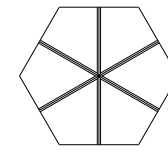

DIAMOND STRIKE
CODE **VSK**

WIDTH 21" (533.4mm)
LENGTH 12" (304.8)

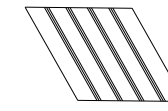

CODE	EDGE	CASE	THICKNESS	COLORS	PRICE
GWT-VXX-24XX09ST	STRAIGHT	8	9mm (3/8")	15	\$ 979
GWT-VXX-24XX12ST	STRAIGHT	8	12mm (1/2")	15	\$ 1276
GWT-VXX-24XX09BE	BEVELED	8	9mm (3/8")	15	\$ 1029
GWT-VXX-24XX12BE	BEVELED	8	12mm (1/2")	15	\$ 1326

PATTERN V-NOTCH SHEETS

Patterned V notching adds visual depth to EzoBord sheets and brings harmony and control to acoustically demanding spaces.



CODE VNO - XXX - XXXXXX
PRODUCT PATTERN CODE WIDTH THICKNESS LENGTH

STANDARD PATTERN TIER A

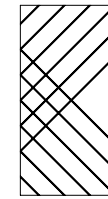

BASKET WEAVE
CODE BAW

WIDTH 47.5" (1207mm)
LENGTH 95" (2413mm)

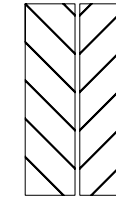

HERRINGBONE
CODE HER

WIDTH 23" (584mm)
LENGTH 95" (2413mm)
Sold in Pairs as Shown

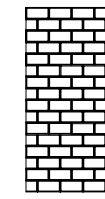

BRICK LARGE
CODE BRL

WIDTH 47.5" (1207mm)
LENGTH 95" (2413mm)

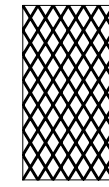

DIAMOND LARGE
CODE DIL

WIDTH 47.5" (1207mm)
LENGTH 95" (2413mm)

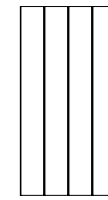

PICKET WIDE
CODE PIW

WIDTH 47.5" (1207mm)
LENGTH 95" (2413mm)

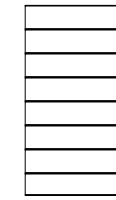

PLANK WIDE
CODE PLW

WIDTH 47.5" (1207mm)
LENGTH 95" (2413mm)

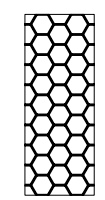

HEXAGON LARGE
CODE HEL

WIDTH 47.5" (1207mm)
LENGTH 95" (2413mm)

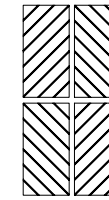

OBLIQUE
CODE OBL

WIDTH 23" (584.2mm)
LENGTH 46" (1168.4mm)
Sold in Sets of Four as Shown

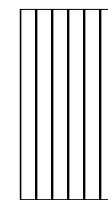

PICKET
CODE PIC

WIDTH 47.5" (1207mm)
LENGTH 95" (2413mm)



PLANK
CODE PLA

WIDTH 47.5" (1207mm)
LENGTH 95" (2413mm)

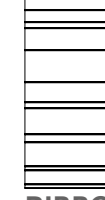

RIBBON
CODE RIB

WIDTH 47.5" (1207mm)
LENGTH 95" (2413mm)

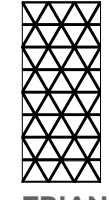

TRIANGLE LARGE
CODE TRL

WIDTH 47.5" (1207mm)
LENGTH 95" (2413mm)

STANDARD PATTERN TIER C

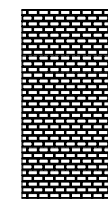

BRICK
CODE BRI

WIDTH 47.5" (1207mm)
LENGTH 95" (2413mm)

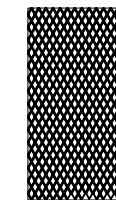

DIAMOND
CODE DIA

WIDTH 47.5" (1207mm)
LENGTH 95" (2413mm)



TRIANGLE
CODE TRI

WIDTH 47.5" (1207mm)
LENGTH 95" (2413mm)

CODE	TIER	THICKNESS	COLORS	PRICE
VNO-XXX-XXXXXX09	A	9mm (3/8")	15	\$ 875
VNO-XXX-XXXXXX12	A	12mm (1/2")	15	\$ 1195
VNO-XXX-XXXXXX09	B	9mm (3/8")	15	\$ 1057
VNO-XXX-XXXXXX12	B	12mm (1/2")	15	\$ 1378
VNO-XXX-XXXXXX09	C	9mm (3/8")	15	\$ 1239
VNO-XXX-XXXXXX12	C	12mm (1/2")	15	\$ 1560

Custom sizes and patterns available on request. Design charges may apply.

Hardware not included.
Options listed in hardware guide pages 46-47

Please contact your local sales representative for more information.
Note that all dimensions are nominal, supplier reserves the right to adjust sizing without prior notification.

WORK ZONE DIVIDER

EzoBord Work Zone Dividers add privacy, color and style, making every office space a better place to work in.

Divide space, absorb sound and create visual privacy all in one simple solution...

EzoBord Work Zone Dividers are cut in various shapes and patterns ranging from organic shapes to geometric shapes to cityscapes. A great way to define space quickly and cost effectively.



CODE W Z D - X X X - X X X X X
 PRODUCT PATTERN WIDTH THICKNESS LENGTH

STANDARD PATTERN TIER A



BAMBOO
CODE BAM

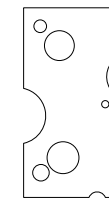

BUBBLE
CODE BUB



CHEVRON
CODE CHE

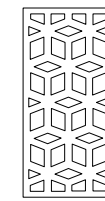

CUBE
CODE CUB

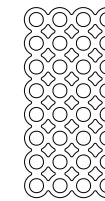

DAIRE
CODE DAI

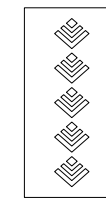

DECO
CODE DEC



FLATLINE
CODE FLA

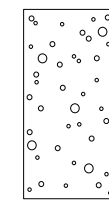

GALAXY
CODE GLX



LEAF
CODE LEA

STANDARD PATTERN TIER B



AZTEC
CODE AZT

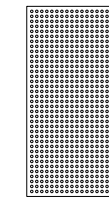

CIRCLES
CODE CIR

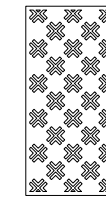

DOKUMA
CODE DOK



KESIK
CODE KES

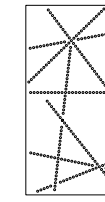

LAZER
CODE LAZ

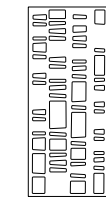

ORMAN
CODE ORM

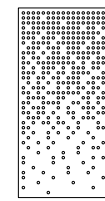

PIXELATED CIRCLES
CODE PXC



PAL
CODE PAL



PIXELATED SQUARES
CODE PXS

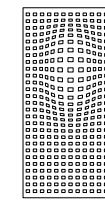

RECTANGULAR UNDULATION
CODE REC

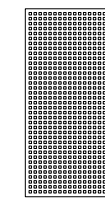

SQUARES
CODE SQR

CODE	TIER	WIDTH	LENGTH	THICKNESS	COLORS	PRICE
WZD-XXX-489609	A	47.5" (1207mm)	95" (2413mm)	9mm (3/8")	15	\$ 875
WZD-XXX-489612	A	47.5" (1207mm)	95" (2413mm)	12mm (1/2")	15	\$ 1195
WZD-XXX-489609	B	47.5" (1207mm)	95" (2413mm)	9mm (3/8")	15	\$ 1057
WZD-XXX-489612	B	47.5" (1207mm)	95" (2413mm)	12mm (1/2")	15	\$ 1378

Custom sizes and patterns available on request. Design charges may apply.

Please contact your local sales representative for more information. Note that all dimensions are nominal, supplier reserves the right to adjust sizing without prior notification.

EZO ON EZO

ezo on ezo gives you style, depth and sound absorption while adding visual appeal, making every office space a better place to work in.

Absorb sound and create visual interest with all in one simple solution...

EzoBord's 'ezo on ezo' product range layers our popular Work Zone Divider patterns on a second layer of contrasting color EzoBord, creating a 3 dimensional, colorful appearance while adding significant sound absorption in your open space.

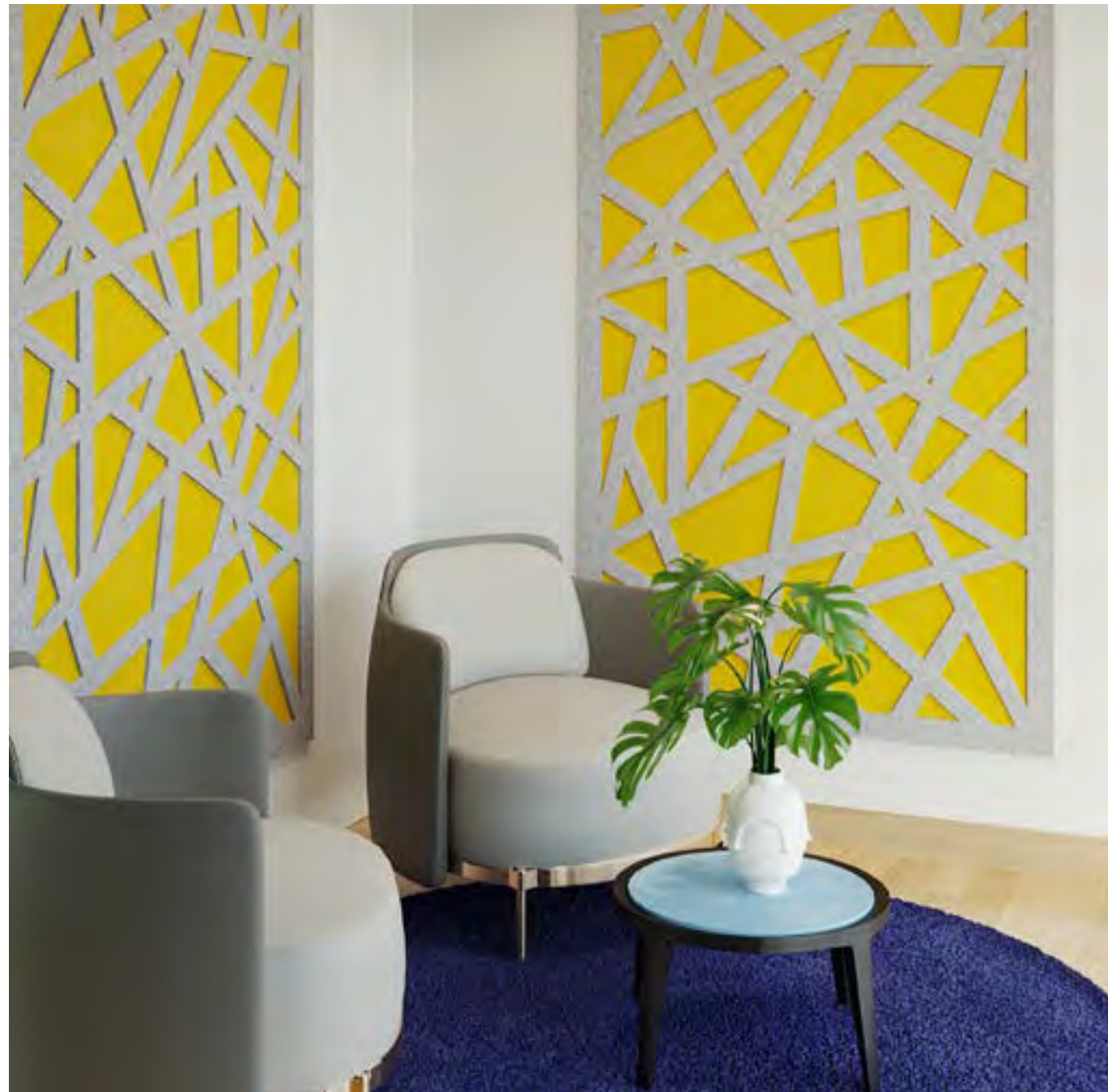

CODE EOE-XXX-XXXX
PRODUCT PATTERN WIDTH LENGTH

STANDARD PATTERN TIER A

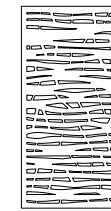

BAMBOO
CODE BAM



BUBBLE
CODE BUB

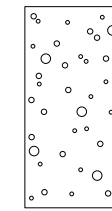

GALAXY
CODE GLX



LEAF
CODE LEA

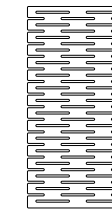

SLOTTED
CODE SLT

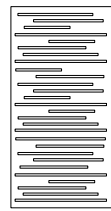

STAGGERED
CODE STG

STANDARD PATTERN TIER B

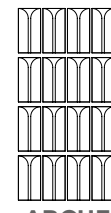

ARCHES
CODE ARC

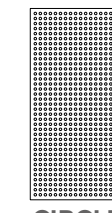

CIRCLES
CODE CIR

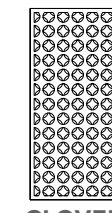

CLOVER
CODE CLO

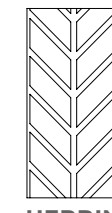

HERRINGBONE
CODE HER

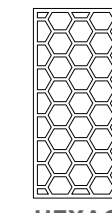

HEXAGON
CODE HEX

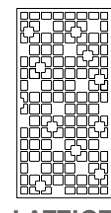

LATTICE
CODE LTT

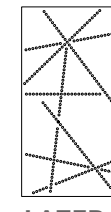

LAZER
CODE LZR

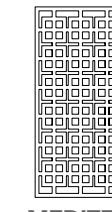

MEDITERRANEAN
CODE MED

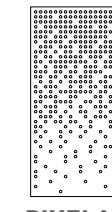

PIXELATED CIRCLES
CODE PXC

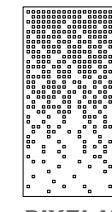

PIXELATED SQUARES
CODE PXS

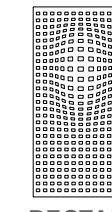

RECTANGULAR UNDULATION
CODE REC

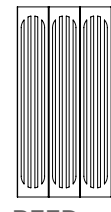

REED
CODE REE

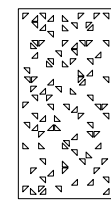

SMALL TRIANGLE
CODE SMT

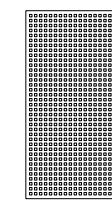

SQUARES
CODE SQR

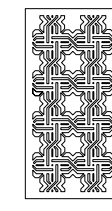

STAR & KNOT
CODE SNK



STRING
CODE STR

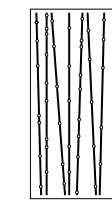

TILT
CODE TLT

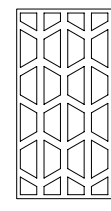

TRAPEZOID
CODE TRA

CODE	TIER	WIDTH	LENGTH	THICKNESS	COLORS	PRICE
EOE-XXX-4896	A	47.5" (1207mm)	95" (2413mm)	18mm	15	\$ 1856
EOE-XXX-4896	A	47.5" (1207mm)	95" (2413mm)	24mm	15	\$ 2277
EOE-XXX-4896	B	47.5" (1207mm)	95" (2413mm)	18mm	15	\$ 1936
EOE-XXX-4896	B	47.5" (1207mm)	95" (2413mm)	24mm	15	\$ 2523

Custom sizes and patterns available on request, Design charges may apply.

EZOPRINT

CODE E Z P - X X X - X X X X X
PRODUCT PATTERN CODE WIDTH LENGTH THICKNESS

ezoPrint adds depth and texture to any wall, improves acoustical comfort in any space and brings practicality and style to any architectural work. You can transform your environment with prints of favorite building materials, abstract designs or your own brand.

Add visual interest to any wall, while providing acoustic absorption, tackability and modern style. With design options ranging from materials that imitate architectural choices to more abstract or branded options, you can transform your environment.

Do you have your own ideas for printing?

Get in touch with us to discuss how we can work together to find a bespoke printed solution for your project.



STANDARD PRINTS

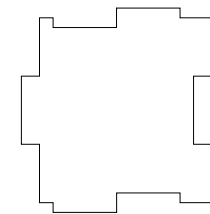
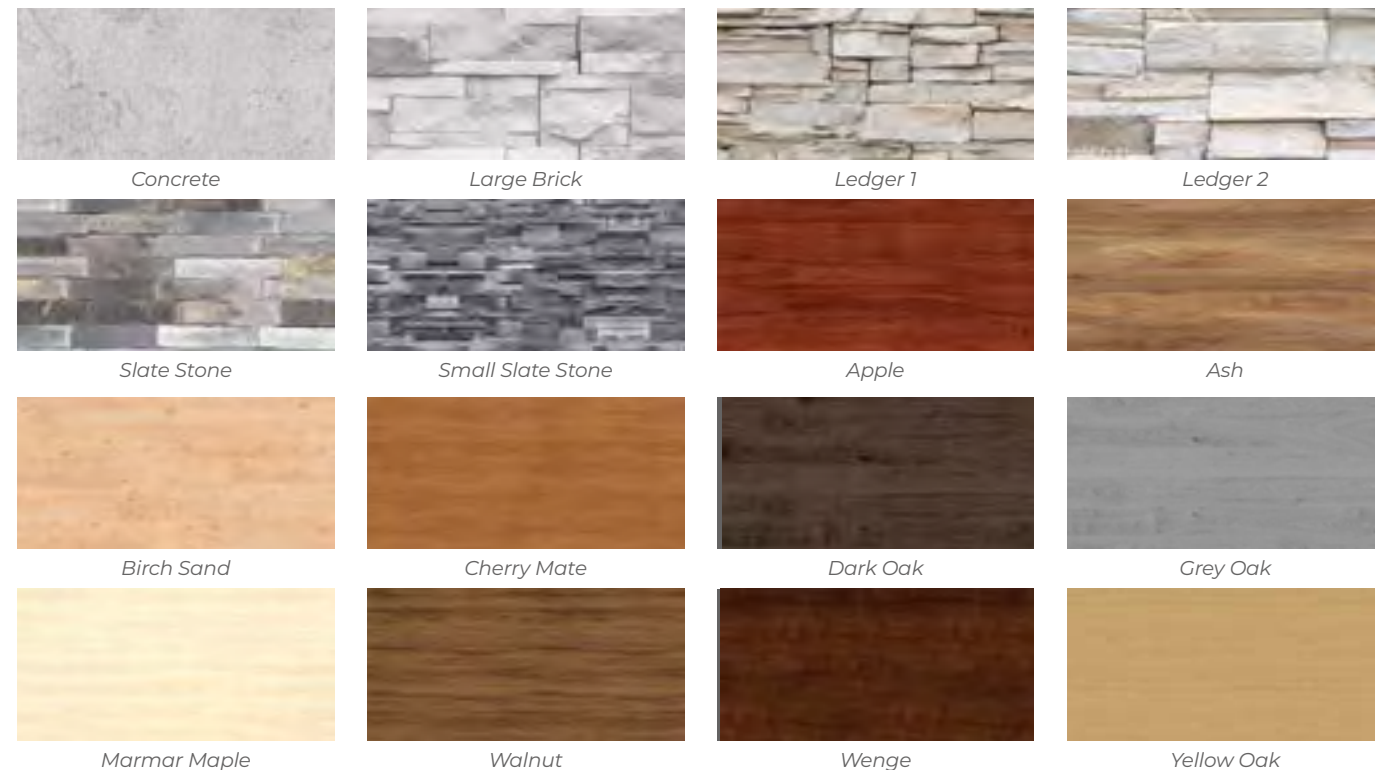

SMALL TILES

WIDTH 21" (533.4mm)
 LENGTH 21" (533.4mm)

Sold in quantities of 8

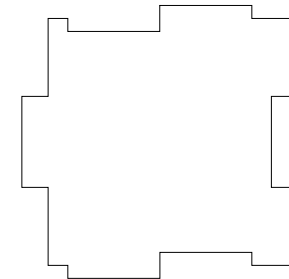

LARGE TILES

WIDTH 42" (1066.8mm)
 LENGTH 42" (1066.8mm)

Sold in quantities of 2

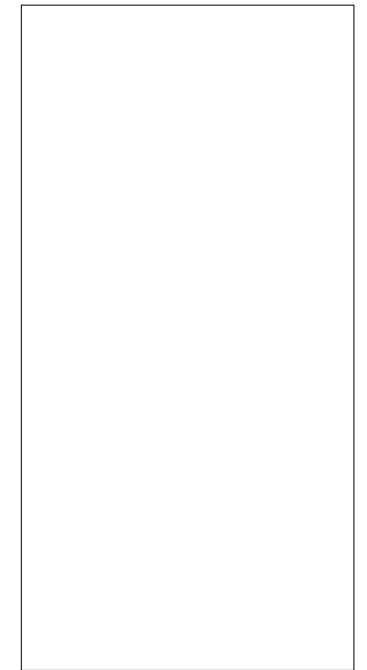

FULL SHEETS

WIDTH 47.5" (1206.5mm)
 LENGTH 95" (2413mm) / 107 (2717.8mm)

EZOPRINT CUSTOM PRINT

EzoBord is available in custom print patterns and colors. Product shape may not match that shown. Shape of tiles dependent on pattern selected. Specific colors on colored sheets may not be available. Classic White ezo material will be used unless otherwise specified. Custom print outcomes will not be guaranteed without printed proof. Please contact your local sales representative or customer service for more information. Extended lead times apply.

CODE	CASE	WIDTH	LENGTH	THICKNESS	PRICE
EZP-XXX-212109	8	21" (533.4mm)	21" (533.4mm)	9mm (3/8")	\$ 1504
EZP-XXX-212112	8	21" (533.4mm)	21" (533.4mm)	12mm (1/2")	\$ 1786
EZP-XXX-424209	2	42" (1066.8mm)	42" (1066.8mm)	9mm (3/8")	\$ 1391
EZP-XXX-424212	2	42" (1066.8mm)	42" (1066.8mm)	12mm (1/2")	\$ 1598
EZP-XXX-489609	1	47.5" (1206.5mm)	95" (2413mm)	9mm (3/8")	\$ 1203
EZP-XXX-489609	1	47.5" (1206.5mm)	95" (2413mm)	12mm (1/2")	\$ 1410

Custom sizes available upon request

PANELS & SHEETS

EzoBord Panels are acoustically effective, customizable, decorative and recycled. Easy to install EzoBord panels and our specialized design teams provide top-notch solutions, endless creative possibilities that ensures superior acoustical performance.

EzoBord panels can be manufactured with custom dimensions and surface engraving in addition to available standard sizes, edges and v-notched surfaces. Consult to our design team for custom tailored solutions.



CODE T A C - R E C - X X X X X X
PRODUCT PATTERN CODE WIDTH THICKNESS HEIGHT

TAC PANELS

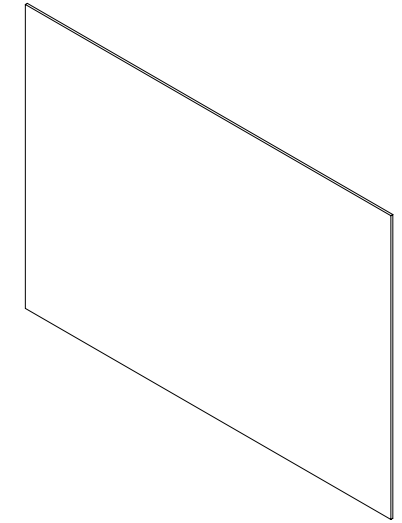

CODE	THICKNESS	COLORS	PRICE
TAC-REC-2448	9mm (3/8")	15	\$ 153
TAC-REC-2448	12mm (1/2")	15	\$ 215

For beveled edge, add \$ 50 flat rate

Tac panels come pre-taped and ready for installation. Custom sizes and shapes available on request.

FULL SHEETS

Size dependant on thickness.

CODE S H E - X X X - X X X X X X
PRODUCT EDGE WIDTH THICKNESS HEIGHT

CODE	EDGE	THICKNESS	COLORS	PRICE
SHE-009-489609	RAW	9mm (3/8")	15	\$ 447
SHE-012-4810812	RAW	12mm (1/2")	15	\$ 653
SHE-SQR-489609	SQUARED	9mm (3/8")	15	\$ 512
SHE-SQR-4810812	SQUARED	12mm (1/2")	15	\$ 718
LAM-018-489618	SQUARED	18mm (3/4")	15	\$ 1189
LAM-024-4810824	SQUARED	24mm (1")	15	\$ 1603

NOTE

Raw sheets available in 9mm (3/8") or 12mm (1/2") only. These do not have finished edges and exact dimensions cannot be confirmed. Usable dimensions of the sheet are guaranteed to be 47.5"x95" (9mm) and 47.5"x107" (12mm). To order finished edge sheets cut to size, standard lead time and cut charges may apply.

DESK DIVIDERS

EzoBord Desk Screens are a great way to absorb sound, add privacy, color and style in any open plan workspace, enhancing speech intelligibility making every office space a better place to work in.

EzoBord desk screens are a welcome addition to any open plan office and are totally customizable for size, shape, hole pattern and color. They are also available in single or double layer to fit any budget or design. EzoBord desk screens are a great, eco-friendly alternative to fabric-covered desk screens.



CODE D S C - X X X - X X X X X
PRODUCT PATTERN CODE WIDTH THICKNESS
HEIGHT

DESK SCREEN

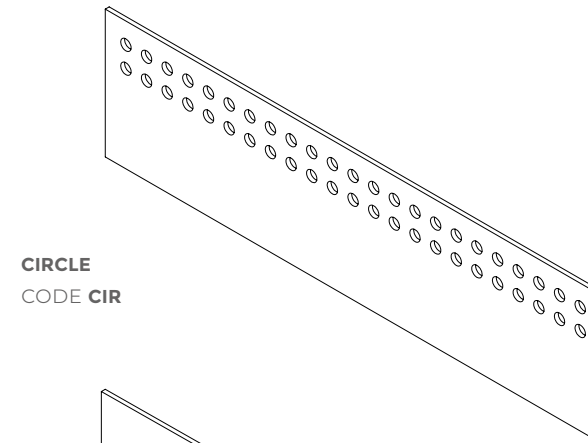

CIRCLE
CODE CIR

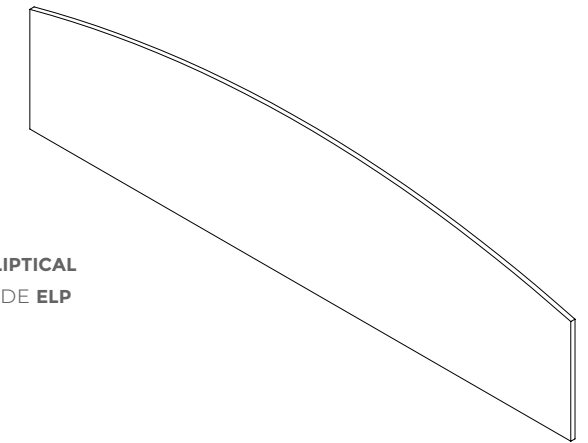

ELLIPTICAL
CODE ELP



RECTANGLE
CODE REC

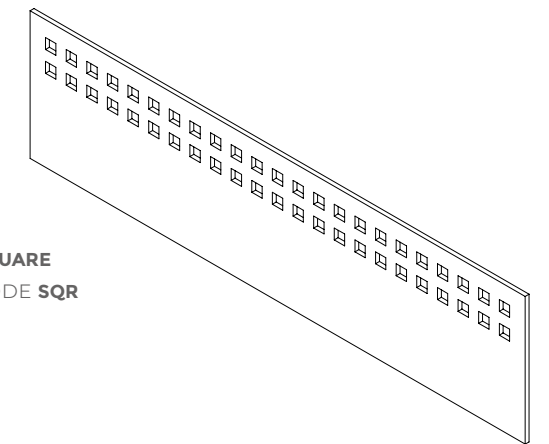

SQUARE
CODE SQR

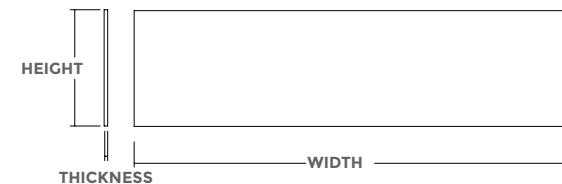

CODE	HEIGHT	THICKNESS	COLORS	PRICE
DSC-CIR-XX1618	15.5" (393.7mm)	18mm (3/4")	15	\$ 79 /LINEAR FT
DSC-CIR-XX1612	15.5" (393.7mm)	12mm (1/2")	15	\$ 46 /LINEAR FT
DSC-CIR-XX2418	23.5" (596.9mm)	18mm (3/4")	15	\$ 118 /LINEAR FT
DSC-CIR-XX2412	23.5" (596.9mm))	12mm (1/2")	15	\$ 67 /LINEAR FT
DSC-ELP-XX1618	15.5" (393.7mm)	18mm (3/4")	15	\$ 69 /LINEAR FT
DSC-ELP-XX1612	15.5" (393.7mm)	12mm (1/2")	15	\$ 36 /LINEAR FT
DSC-ELP-XX2418	23.5" (596.9mm))	18mm (3/4")	15	\$ 103 /LINEAR FT
DSC-ELP-XX2412	23.5" (596.9mm))	12mm (1/2")	15	\$ 54 /LINEAR FT
DSC-REC-XX1618	15.5" (393.7mm)	18mm (3/4")	15	\$ 69 /LINEAR FT
DSC-REC-XX1612	15.5" (393.7mm)	12mm (1/2")	15	\$ 36 /LINEAR FT
DSC-REC-XX2418	23.5" (596.9mm))	18mm (3/4")	15	\$ 103 /LINEAR FT
DSC-REC-XX2412	23.5" (596.9mm))	12mm (1/2")	15	\$ 54 /LINEAR FT
DSC-SQR-XX1618	15.5" (393.7mm)	18mm (3/4")	15	\$ 79 /LINEAR FT
DSC-SQR-XX1612	15.5" (393.7mm)	12mm (1/2")	15	\$ 46 /LINEAR FT
DSC-SQR-XX2418	23.5" (596.9mm))	18mm (3/4")	15	\$ 118 /LINEAR FT
DSC-SQR-XX2412	23.5" (596.9mm))	12mm (1/2")	15	\$ 67 /LINEAR FT

Custom sizes available upon request

Please contact your local sales representative for more information.
 Note that all dimensions are nominal, supplier reserves the right to adjust sizing without prior notification.

DESK DIVIDERS

MODESTY SCREEN

Full height for above and below the desk surface

CODE M D S - X X X - X X X X X X
PRODUCT SHAPE CODE WIDTH LENGTH THICKNESS

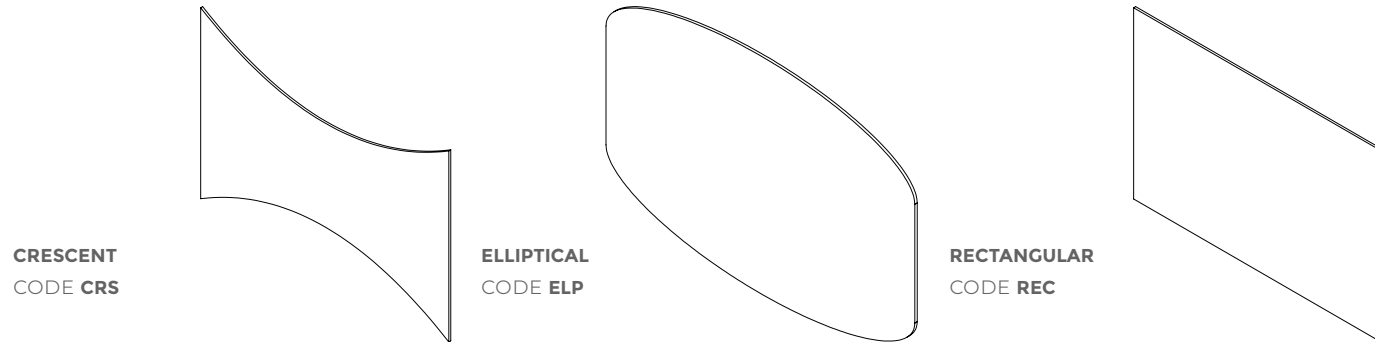

CODE	HEIGHT	THICKNESS	COLORS	PRICE
MDS-CRS-XX4018	40" (1016mm)	18mm (3/4")	15	\$170 /LINEAR FT
MDS-CRS-XX4012	40" (1016mm)	12mm (1/2")	15	\$108 /LINEAR FT
MDS-ELP-XX4018	40" (1016mm)	18mm (3/4")	15	\$170 /LINEAR FT
MDS-ELP-XX4012	40" (1016mm)	12mm (1/2")	15	\$108 /LINEAR FT
MDS-REC-XX4018	40" (1016mm)	18mm (3/4")	15	\$170 /LINEAR FT
MDS-REC-XX4012	40" (1016mm)	12mm (1/2")	15	\$108 /LINEAR FT

MODESTY PANEL

For mounting below the desk surface

CODE M D P - X X X - X X X X X X
PRODUCT SHAPE CODE WIDTH LENGTH THICKNESS

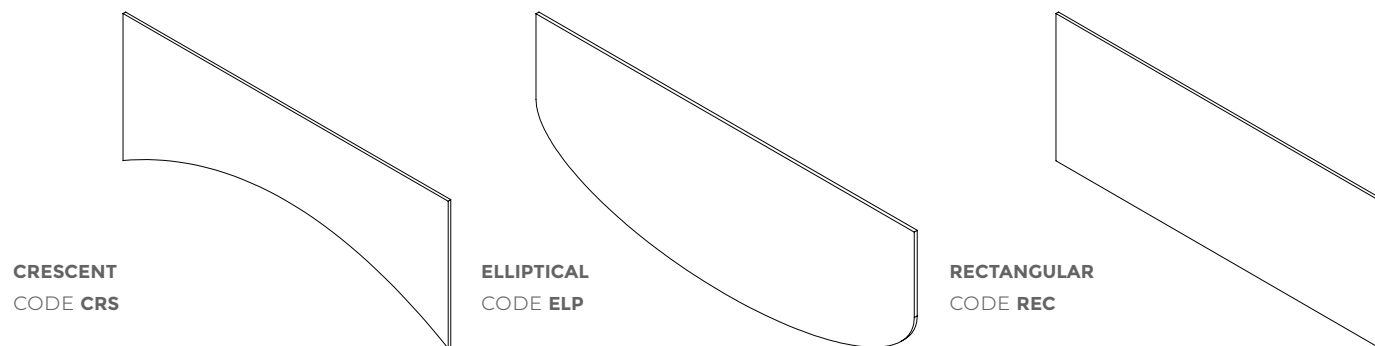

CODE	HEIGHT	THICKNESS	COLORS	PRICE
MDP-CRS-XX4018	23.5"(596.9mm)	18mm (3/4")	15	\$85 /LINEAR FT
MDP-CRS-XX4012	23.5"(596.9mm)	12mm (1/2")	15	\$54 /LINEAR FT
MDP-ELP-XX4018	23.5"(596.9mm)	18mm (3/4")	15	\$85 /LINEAR FT
MDP-ELP-XX4012	23.5"(596.9mm)	12mm (1/2")	15	\$54 /LINEAR FT
MDP-REC-XX4018	23.5"(596.9mm)	18mm (3/4")	15	\$85 /LINEAR FT
MDP-REC-XX4012	23.5"(596.9mm)	12mm (1/2")	15	\$54 /LINEAR FT

CODE S T C - X X X - X X X X X X
PRODUCT SHAPE CODE WIDTH HEIGHT THICKNESS

STUDY CARREL

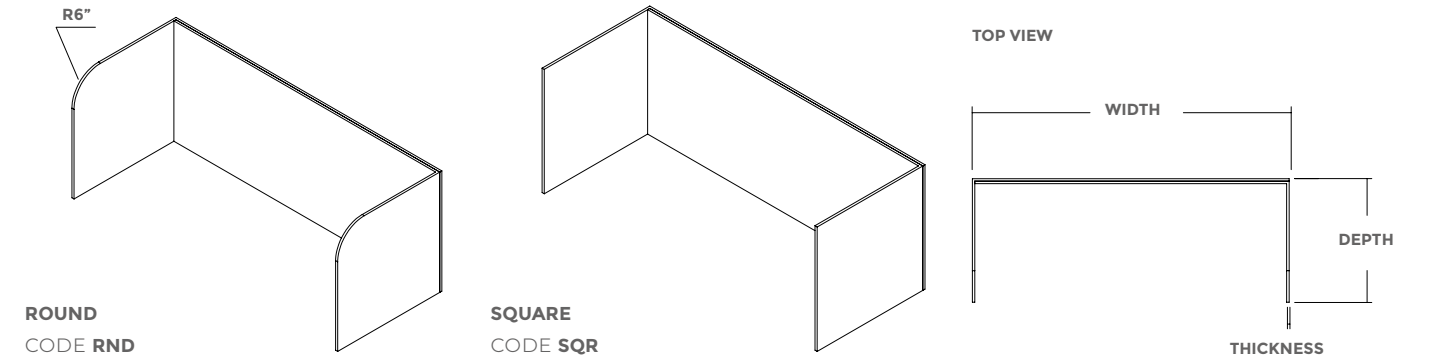

CODE	WIDTH	DEPTH	HEIGHT	THICKNESS	COLORS	PRICE
STC-XXX-48242412	48"	23.5"(596.9mm)	23.5"(596.9mm)	12mm (1/2")	15	\$889 EA
STC-XXX-60242412	60"	23.5"(596.9mm)	23.5"(596.9mm)	12mm (1/2")	15	\$1006 EA
STC-XXX-72242412	72"	23.5"(596.9mm)	23.5"(596.9mm)	12mm (1/2")	15	\$1147 EA

RETURN SCREEN

CODE R T S - R N D - X X X X X X
PRODUCT SHAPE CODE WIDTH HEIGHT THICKNESS

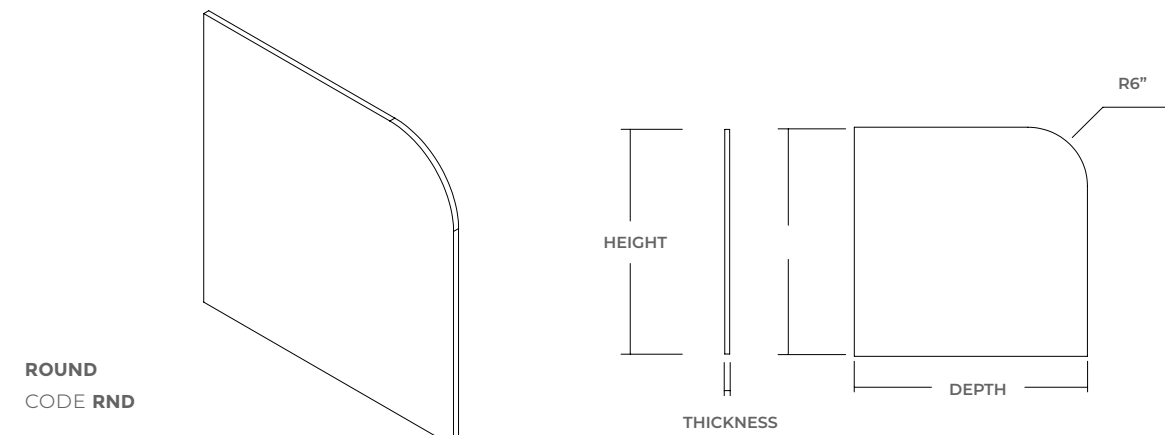

CODE	DEPTH	HEIGHT	THICKNESS	COLORS	PRICE
RTS-RND-241618	23.5(596.9mm)	15.5"(393.7mm)	18mm (3/4")	15	\$120
RTS-RND-241612	23.5(596.9mm)	15.5"(393.7mm)	12mm (1/2")	15	\$72
RTS-RND-242418	23.5(596.9mm)	23.5(596.9mm)	18mm (3/4")	15	\$179
RTS-RND-242412	23.5(596.9mm)	23.5(596.9mm)	12mm (1/2")	15	\$108
RTS-RND-301618	30" (762mm)	15.5"(393.7mm)	18mm (3/4")	15	\$159
RTS-RND-301612	30" (762mm)	15.5"(393.7mm)	12mm (1/2")	15	\$96
RTS-RND-302418	30" (762mm)	23.5(596.9mm)	18mm (3/4")	15	\$238
RTS-RND-302412	30" (762mm)	23.5(596.9mm)	12mm (1/2")	15	\$143

HOODY

Instantly transform your open plan office space into individually separated, quiet workspaces with EzoBord's modular Hooded Desk divider system nicknamed "Hoody".

The "Hoody" installs in seconds without the use of any tools and fits onto any new or existing desking/benching system. Compatible with virtually any manufacturer including all major office furniture brands.



CONFIGURATIONS



SINGLE HOODY

'Hoody's' can be added in seconds to any fixed height or adjustable height desks. No tools required.



LINKED HOODY'S

For fixed height workstations, infinitely link 'Hoody's' together on any fixed height bench system



MULTIPLE INDEPENDENT HOODY'S

For use with height adjustable desking applications. Configurable in rows or back to back creating left/right and vertical social barriers. Add as many 'Hoody's' as you require.

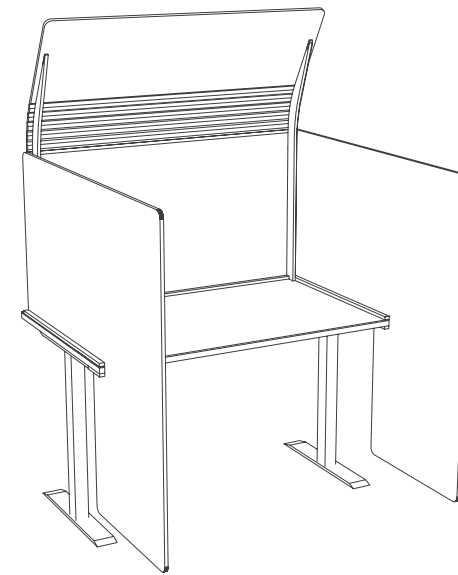

RETURN SCREEN
CODE RTS

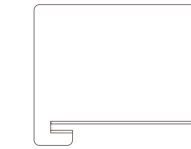

EXTENDED
RETURN SCREEN
CODE ERS

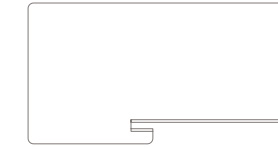

FULL HEIGHT
RETURN SCREEN
CODE FRS

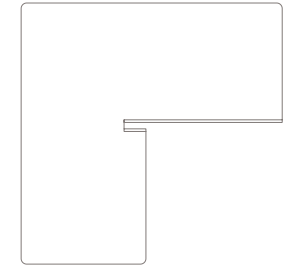

CODE HDS - XRS - XXXXX12
PRODUCT SHAPE CODE DEPTH WIDTH HEIGHT THICKNESS

CODE HDS - BSX - XX4512
PRODUCT SIZE CODE WIDTH HEIGHT THICKNESS

HOODY TALL 48"
CODE BST

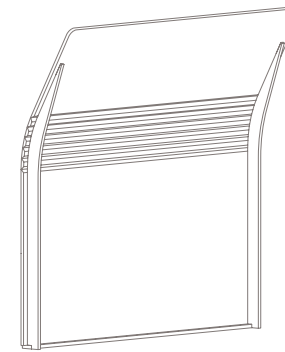

HOODY GRANDE 60"
CODE BSG

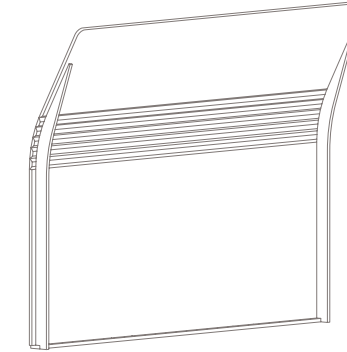

HOODY VENTI 72"
CODE BSV

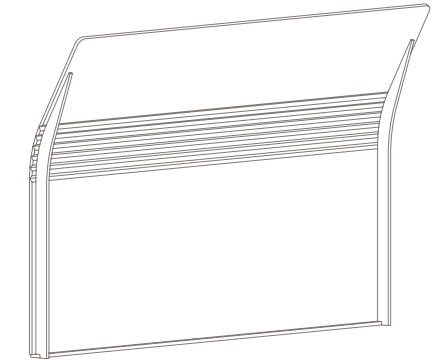

CODE	WIDTH	HEIGHT	DEPTH	THICKNESS	COLORS	PRICE
HDS-RTS-24322212		24" (609.6mm)	24" (609.6mm)	12mm (1/2")	15	\$174
HDS-RTS-30322212		24" (609.6mm)	30" (762mm)	12mm (1/2")	15	\$184
HDS-ERS-24472212		24" (609.6mm)	24" (609.6mm)	12mm (1/2")	15	\$221
HDS-ERS-30472212		24" (609.6mm)	30" (762mm)	12mm (1/2")	15	\$231
HDS-FRS-24472212		24" / 47"	24" (609.6mm)	12mm (1/2")	15	\$385
HDS-FRS-30472212		24" / 47"	30" (762mm)	12mm (1/2")	15	\$395
HDS-BST-24322212	48" (1219.2mm)	45" (1143mm)		12mm (1/2")	15	\$616
HDS-BSG-24322212	60" (1524mm)	45" (1143mm)		12mm (1/2")	15	\$714
HDS-BSV-24322212	72" (1828.8mm)	45" (1143mm)		12mm (1/2")	15	\$814

OBI

MOBILE OFFICE DIVIDER

OBI Mobile office dividers are the perfect way to instantly transform any space into places where people meet collaborate, share and learn.

Ruggedly built, totally mobile and 'nestable', OBI Office Dividers feature EzoBord acoustical surface materials and are available in a variety of visually interesting patterns. OBI office dividers are also available with magnetic rewriteable surface options and shelf and file storage options making them perfect for mutli task/meeting environments



SUGGESTED CONFIGURATIONS



CODE O B 2 - E Z O - X X X X X X
PRODUCT PATTERN CODE WIDTH THICKNESS LENGTH

CODE O B 2 - S H F - 4 7 0 8 1 2

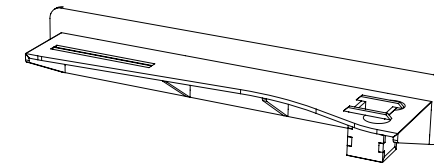

CODE O B 2 - F I L - 1 5 1 4 1 2

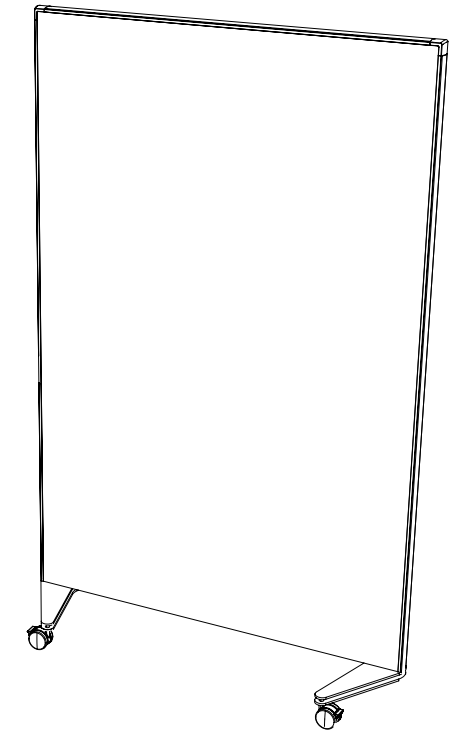
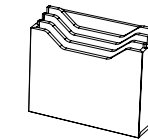

EZO: PLAIN EZO BOTH SIDES
PLW: PLAIN ONE SIDE WHITEBOARD OTHER SIDE

CODE	WIDTH	HEIGHT	THICKNESS	COLORS	PRICE
OB2-EZO-486012	48"	64.5"	12mm (1/2")	15	\$ 2925
OB2-PLW-486012	48"	64.5"	12mm (1/2")	15	\$ 3050
OB2-EZO-487212	48"	76.5"	12mm (1/2")	15	\$ 2975
OB2-PLW-487212	48"	76.5"	12mm (1/2")	15	\$ 3175
OPTIONAL PATTERNS					\$ 875
OB2-SHF-470812	Whiteboard Shelf				\$ 375
OB2-FIL-151412	Whiteboard File Holder				\$ 325

OPTIONAL PATTERNS



BAMBOO
CODE BAM

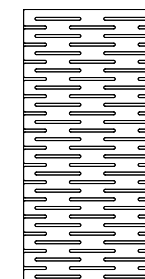

SLOTTED
CODE SLT



STAGGERED
CODE STG

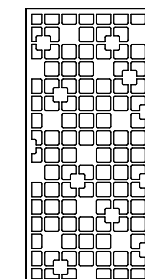

LATTICE
CODE LIT

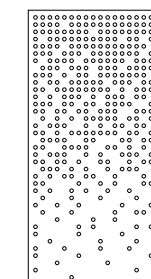

PIXELATED CIRCLES
CODE PXC

SUSPENDED OFFICE

CODE **SUS - XXX - XXXX**
 PRODUCT CONFIG WIDTH LENGTH

There really isn't a "one size fits all" solution, privacy encompasses many different needs and behaviors, each form of privacy - acoustical, informational or visual, helps people to feel free, to share ideas and to make work visible.

Designed in collaboration with B2Lab, Suspended Office is an ecosystem of spaces that re-define the privacy of the work area and shape collaborative work.

Featuring EzoBord acoustical surface materials in a variety of visually interesting patterns, colors, and configurations that perfectly balance design and functionality.

CONFIGURATION OPTIONS

SINGLE MODULE
CODE SIG

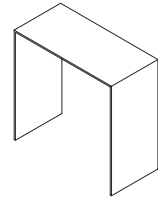

DOUBLE MODULE
CODE DBL

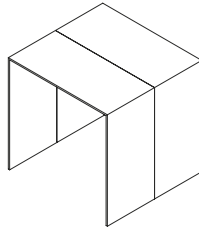

"L" SHAPE
CODE ELL

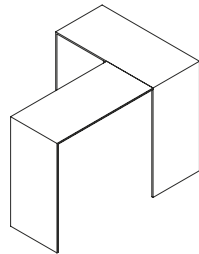

OPTIONAL PATTERNS

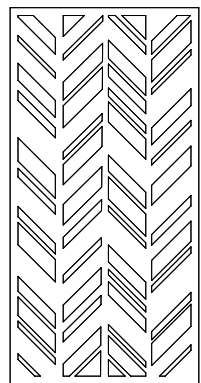

CHEVRON
CODE CHE

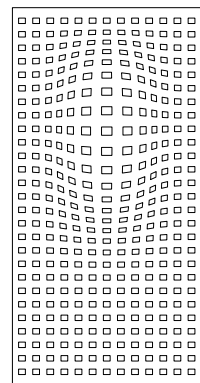

RECTANGULAR
UNDULATION
CODE REC

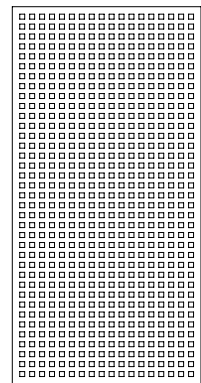

SQUARES
CODE SQR

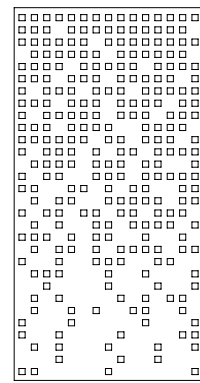

PIXELATED
SQUARES
CODE PXS

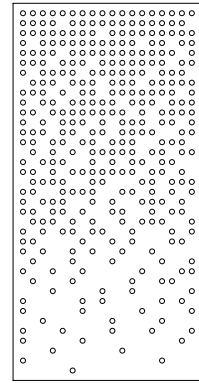

PIXELATED
CIRCLES
CODE PXC

CODE	WIDTH	LENGTH	COLORS	PRICE
SUS-SIG-4896	48"	96"	15	\$ 9975
SUS-DBL-9696	96"	96"	15	\$ 20500
SUS-ELL-96144	96"	144"	15	\$ 16750

SLIDING TRACK ADD-ON

SUS-SLI-4896	\$ 3300
SUS-SLI-9696	\$ 4500

HARDWARE GUIDE

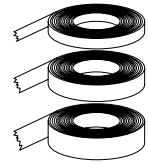

EZO TAPE *Sold Individually*

Specially formulated permanent double sided tape for vertical wall application. Not for use on all types of surface finishes. Available in three widths at 164' (50m) length rolls

DST-010 1"	\$140
DST-015 1.5"	\$211
DST-020 2"	\$279



1" STAND OFF / STO-25 *Sold Individually*

13mm (1/2") Diameter, 25mm (1") Depth.
For wall application only. Intended for use with 9mm (3/8") - 12mm (1/2") material.

\$25

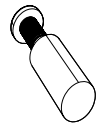

2" STAND OFF / STO-50 *Sold Individually*

1" Diameter, 50mm Depth.
For wall application only. Intended for use with 9mm (3/8") - 24mm (1") material.

\$33



UPPER SUSPENSION HOUSING / CF6-01 *Sold Individually*

Ceiling fitting to be used with mechanical fastener.
Includes 13'-1 1/2" (4m) of cable. Brass Locator accepts #8 Screws, not included.

\$38



LOWER SUSPENSION HOUSING / CF6-02 *Sold Individually*

For use with Wire Suspension Track. Includes 13'-1 1/2" (4m) of wire.
Not intended for ceiling suspension applications.

\$50



WIRE SUSPENSION TRACK *Sold Individually*

To be used with Upper and/or Lower Suspension Housing.
Specify brass slot nuts for housing attachments. Available in two lengths:

XC-04-1000 39" (1000mm)	\$112
XC-04-2000 80" (2036mm)	\$248

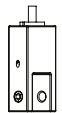

ADJUSTABLE COMBINATION CLAMP / CBG-C *Sold Individually*

Compatible with Upper and Lower Suspension Housing.
Intended for use with 9mm (3/8") and 12mm (1/2") material. Specify placement on material for use with larger thicknesses.

\$50



DOUBLE EZO CLAMP / CVD *Sold Individually*

Clamp intended to connect two 9mm (3/8") pieces of material. Specify placement on material for use with alternate thicknesses.

\$38



LOOPING CABLE GRIPPER / CG7250 *Sold Individually*

Adjustable wire looping system. Compatible with Upper Suspension Housing or Eye Hook application.

\$31

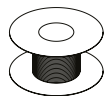

CABLE

1/16" wire. Compatible with all EzoBord hardware options.

Spools of 250' (76m)	\$187
Spools of 100' (30.48m)	\$94

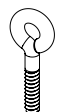

EYE HOOK / EY001 *Sold in Packages of 50*

For use with individually suspended baffles.
Not recommended for ceiling application.

\$56

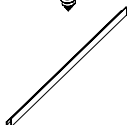

ALUMINIUM J TRIM / FR3138 *Sold in 8' lengths*

For use with 9mm (3/8") material only.
Available in lengths up to 8'. Minimum order requirements may apply.

\$14 /FT

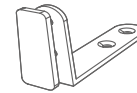

PJ 15/17 UNDER MOUNT MODESTY BRACKET \$34
Compatible with 12mm and 18mm material



T-BAR CLIP W/ RIVETS \$7
Compatible with standard 15/16" t-grid systems



EZO STANDOFF
EzoBord Standoff 4' length (for wall applications only)

12mm	\$15
18mm	\$21
24mm	\$24
48mm	\$46

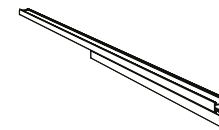

FREE RUNNING SYSTEM
Sliding track system for full sheets or work zone dividers.
Wall application requires Wall Mount Brackets.
Available with 9mm (3/8") material only.

TRK-396-WHT	\$199 /FT
TRK-296-WHT	\$194 /FT

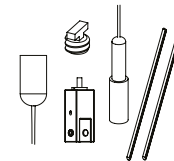

COMPLETE SUSPENSION KIT / K-WZDC *Sold Individually* \$598
For use with Work Zone Dividers. Ezo on ezo.
Includes:

- 2x Wire Suspension Track (39")
- 2x Upper Suspension Housing
- 2x Lower Suspension Housing
- 4x Adjustable Combination Clamp

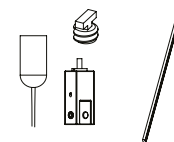

UPPER SUSPENSION KIT / K-WZDU *Sold Individually* \$287
For use with Work Zone Dividers. Ezo on ezo.
Includes:

- 1x Wire Suspension Track
- 2x Upper Suspension Housing
- 2x Adjustable Combination Clamp

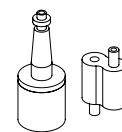

FOUR WAY SUSPENSION COUPLER / GR-1/4-20 *Sold Individually* \$174
For use with Circle Geo Clouds only.
Includes:

- 1x Four Hole Suspension Unit
- 1x 120" (3048mm) Cable
- 4x Looping Cable Gripper



SURFACE MOUNT DESK SCREEN BRACKET / PJ3 *Sold Individually* \$38
Compatible with material 12mm, or 18mm thick.



SURFACE MOUNT DESK SCREEN BRACKET LARGE / PJ9 *Sold Individually* \$41
Compatible with material 12mm, 18mm or 24mm thick.

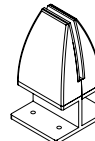

UNDER MOUNT DESK SCREEN DIVIDER BRACKET / PJ101 *Sold Individually* \$44
Compatible with material 12mm or 18mm thick.
Surface thickness limited to 1" - 1 1/4"

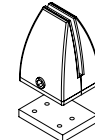

UNDER MOUNT DESK SCREEN BRACKET / PJ4 \$44
Compatible with material 12mm or 18mm thick.
Surface thickness limited to 1" - 1 1/4"

SPECIFICATIONS

COMPOSITION

100% Polyester (min 50% (+/-) recycled PET fiber).

THICKNESS

Available in two thicknesses:

9mm (3/8")

12mm (1/2")

WEIGHT

9mm (3/8"): 8.5 lbs (+/- 5%)

12mm (1/2"): 16 lbs (+/- 5%)

STIFFNESS

70 (Shore Durometer) minimeter

DIMENSIONS

9mm (3/8"): 48 (1206.5mm) x 96 (2413mm)

(+/- 1mm) standard sizing.

12mm (1/2"): 48 (1206.5mm) x 108 (2717.8mm)

(+/- 1mm) standard sizing.

FIRE TESTING

ASTM E-84 Class A / CAN ULC S102-10.

COLORS 3/8" (9mm)



COLORS 1/2" (12mm)



ENVIRONMENT

Made with recycled polyester fiber, 50% +/- of which comes from recycled water bottles which contributes to LEED MR credit of Recycled content.

Free of adhesives and formaldehyde. VOC free.

ACOUSTICS

Refer to ASTM C423 test chart for specific absorption rates/frequency.

9mm (3/8"):

ASTM C423/D: NRC = 0.75; ASTM C423/A: NRC = 0.35

12mm (1/2"):

ASTM C423/D: NRC = 0.85; ASTM C423/A: NRC = 0.45

PRODUCT VARIANCES

Variation in fiber mix and color may occur. All products will be supplied within commercial tolerances.

GENERAL

Tackable, impact resistant, bacteria resistant, moisture resistant, installation friendly.

CUT TYPES

EDGE OPTIONS

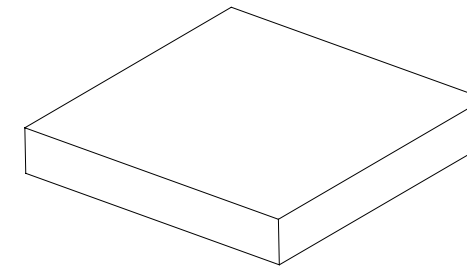

STRAIGHT EDGE

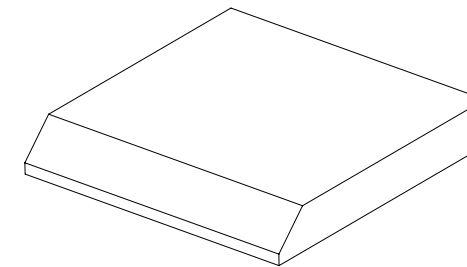

BEVELED EDGE

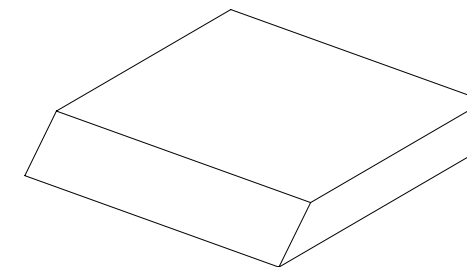
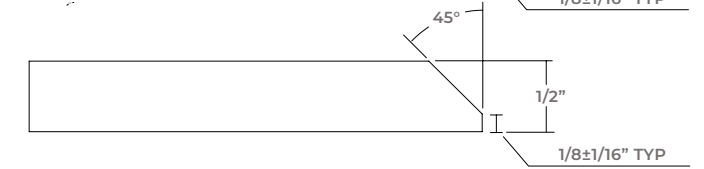
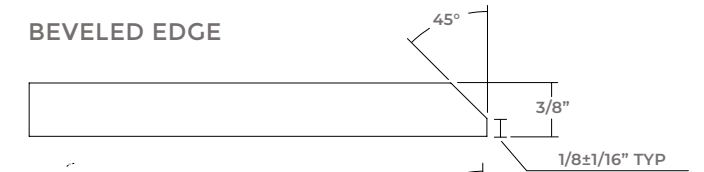

CHAMFERED EDGE



CORNER OPTIONS

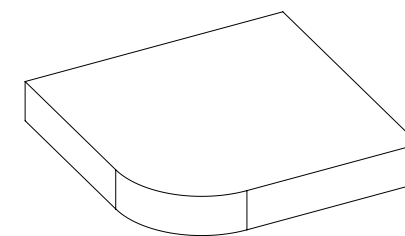

FILLETED

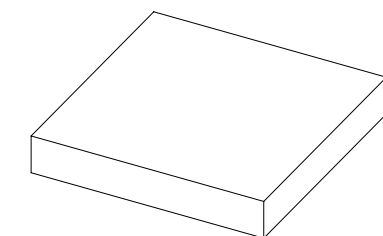
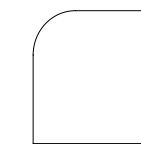

SQUARE

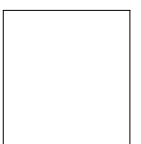

SURFACE OPTIONS

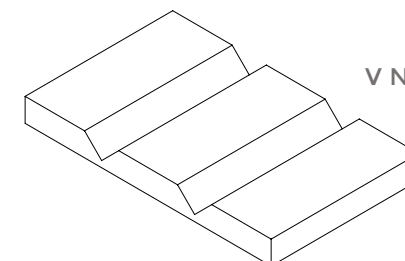

V NOTCH

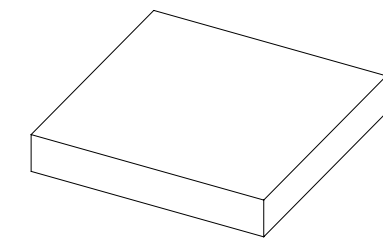

FLAT

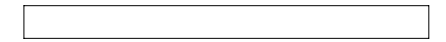

CONDITION OF SALE, RETURN POLICY & WARRANTY FOR AYRSONICS INC.

DEFINITIONS

“Purchaser” refers to the organization or person who accepts a quotation or offer for the sale of “Goods” from the Seller.

“Seller” refers to [AYRSONICS HEAD OFFICE - 825 TRILLIUM DRIVE, KITCHENER, ONTARIO].

“Goods” or “Products” refers to the articles to be supplied to the Purchaser by the AYRSONICS. All “Products” are made-to-order, with the exception of raw materials such as sheets and hardware.

“Quotation” or “Quote” is the calculated cost on requested products based on specifications provided by the Purchaser to AYRSONICS.

“Order” refers to a purchase order, a blanket purchase agreement, a blanket purchase order, a job or work order, or other mechanism for ordering Products.

“Shop Drawings” refer to a set of drawings produced by AYRSONICS to depict Preliminary, Quote-Level, Proposal, Sign-off, Manufacturing, and Installation details pertinent to the successful completion of a project. All drawings are submitted to the Purchaser by AYRSONICS.

“Design Partner” refers to any organization or person who may make a significant contribution to the intellectual direction of a research proposal or a research project.

“Project” shall mean the research activities necessary to achieve a research, development, and /or formation, objective of a design proposal, or design idea. The deliverables of which address a technical or functional ability.

“Background Intellectual Property” refers to any and all intellectual property conceived, developed, made or acquired by AYRSONICS prior to the collaboration of a Project, with a Design Partner or Purchaser.

GOVERNING PROVISIONS:

These Terms and Conditions govern any Quotation, Order Acknowledgment, Invoice, or any agreement, order, or sale that may result from any contract, and is expressly limited to and made conditional upon these Terms and Conditions becoming part of the Agreement between the Purchaser and the Seller [AYRSONICS]. Any variation to these Terms and Conditions contained herein, whether contained in a request for Quotation, Purchase Order, or other document by the Purchaser Including any special Terms and Conditions agreed upon between the parties are hereby objected to and shall be inapplicable unless agreed to in writing by AYRSONICS.

SALES QUOTE INFORMATION:

Acceptance of the quotation by the Purchaser constitutes a binding agreement. Prices quoted by AYRSONICS are based on standard EzoBord products as detailed in the Price and Product Guide and on information provided by the Purchaser. Any changes to standard EzoBord products including but not limited to size or pattern, will be classified as a “custom” product. Pricing of

custom products is based on specifications provided by Purchaser and will be priced at the discretion of AYRSONICS.

Additional charges may apply where the scope of work varies from that set out in the quote. Prices are prepared in Canadian dollars. Delivery and taxes may be subject to change and are based on point of transfer. AYRSONICS does not provide quotes for installation. Quotes are valid for a period of 30 days, after which pricing may change. Possession of the EzoBord Price List or any other literature shall not imply AYRSONICS willingness to sell to the holders and shall not be constructed as a direct offer of sale. AYRSONICS reserves the right to make changes at any time and without prior notice to prices, colors, materials, specifications, design, and models offered in the price list, as well as discontinue product at any time without prior notice.

ORDER INFORMATION:

AYRSONICS requires that all orders be submitted in writing. All orders which require fabrication shall include detailed shop drawings. Once all specifics (size, thickness, pattern, color etc.) have been confirmed, the Purchaser will receive an Order Acknowledgment which will outline items ordered, pricing, ship-to and bill-to details. Orders with missing, or incorrect information may delay lead times. A production date cannot be established until Purchaser has provided all related information and documents, such as deposit payments, and signed shop drawings pertaining to the order. If the Purchaser does not agree with any details outlined in the Order Acknowledgment, AYRSONICS must be notified by email within three business days of receiving the Order Acknowledgment. All orders are subject to a minimum net charge of \$250.

SHOP DRAWINGS:

If the purchase order requires shop drawings, AYRSONICS shall coordinate all such drawings, will review them for accuracy, completeness, and compliance with purchase order requirements. Sign-off by Purchaser constitutes acceptance of all technical details depicted in the drawings; including all dimensions, colors, patterns, quantities, and design criteria. Sign-off is a requirement for the initiation of AYRSONICS fabrication. Information contained in the Shop Drawings are the sole property of AYRSONICS. Any reproduction in part or as a whole without the written permission of AYRSONICS is prohibited.

RESEARCH, DEVELOPMENT, RESULTS, AND INTELLECTUAL PROPERTY:

The Purchaser and/or Design Partner agrees that any design proposal, shop drawing, or rendering, including but not limited to, specifications, formulae, improvements,

processes, methods, techniques, prototypes, data, reports, or discoveries, contains proprietary information and material is owned by AYRSONICS and is protected by applicable intellectual property legislation. The Purchaser and/or Design Partner may not use the Intellectual Property for any purpose other than that contracted in a written agreement between AYRSONICS and the Purchaser.

A written collaboration agreement shall be signed by the Purchaser and/or Design Partner before any research project is initiated. Purchaser and/or Design Partner agrees any Design Proposals or Research Project Design intent, preliminary design, or design development shall be performed by, in collaboration with, or under the direct supervision of AYRSONICS. All written and oral information and material disclosed or provided by AYRSONICS to the Purchaser is confidential information. The Purchaser shall use all reasonable endeavors not to disclose to any third party any Confidential Information nor use for any purpose except expressly permitted by AYRSONICS. Purchaser may be required to sign a Non-disclosure Agreement. All Background Intellectual Property used in connection with the Project shall remain the property of AYRSONICS. AYRSONICS has the right to reuse methods and approaches developed under this agreement in other projects for other purposes.

PRINT PROGRAM:

A digital proof sign-off is required prior to manufacturing. Sign-off by Purchaser constitutes acceptance of all technical details depicted in the digital proof. A digital proof does not guarantee correct color matching. Physical proof must be requested by Purchaser to verify final color of product as there may be a variation between the digital proof and printed product. AYRSONICS shall not be liable for any deviations, errors, and faults that remained unnoticed in the proofs that were approved by the Purchaser or for any spelling or grammatical errors in the graphic file provided by the Purchaser.

CHANGES AND CANCELLATIONS:

After AYRSONICS acknowledgment of a Purchaser's order, the order may not be changed or canceled by Purchaser without the written consent of AYRSONICS. Orders already in production may not be eligible for cancellation or change or may be subject to a cancellation fee, restocking fee, and payment for all product which has been cut, at the discretion of AYRSONICS management. If the order requires major changes, the order may be sent back to the quoting department for new pricing. [Major changes may include but are not limited to the addition of new items, dimension, pattern, and design feature changes]. Sheet order changes after payment may be subject to a cancellation or a change order fee of 25%. AYRSONICS reserves the right to cancel an order at any time.

RETURNS, CLAIMS, AND INQUIRIES:

All return requests are handled by AYRSONICS authorized dealers or AYRSONICS Customer Service Department. All return requests must be submitted within 30 days from date of receipt. No returns of goods will be accepted without consent and shipping instructions from AYRSONICS. If authorized, Purchaser must complete AYRSONICS Product Return Request Form and ship all product to AYRSONICS within one week of receiving the Product Return Request Form. All authorized return of goods must be securely packaged by the Purchaser in order to reach AYRSONICS without damage. A minimum restocking charge of 50% on fabricated products, is made on all authorized returns for credit or refund, provided goods are received by AYRSONICS in the condition in which they left the factory. Raw materials such as sheets and hardware are subject to a minimum 25% restocking fee. No credit will be given if goods cannot be reused. Custom order items are in no event subject to return.

PRICE AND PAYMENT:

All published prices are list prices. Prices on an Order Acknowledgment are net. Any products sold is the property of AYRSONICS and shall remain AYRSONICS property until fully paid. The Purchaser agrees to perform all acts which may be necessary to assure retention of title to such products to AYRSONICS, until such time as the goods have been paid for in full. Invoices will be sent by AYRSONICS to the Purchaser and will be as detailed in the Order Acknowledgment and in accordance with the agreed schedule in the Order Acknowledgment. Not included in the list price is special or export packing, freight, unpacking or installation. A 50% deposit amount against the total amount of the project, is required for Cash in Advance Purchasers, prior to scheduling production. The 50% final payment must be received by AYRSONICS prior to shipping. Sheet orders require a 100% deposit for Cash in Advance Purchasers.

N15 TERMS:

Purchaser on terms shall pay invoices within 15 days after the date of shipment or pickup, subject to the Purchaser passing credit approval. All payments are fully due. Purchaser agrees not to withhold payment on any invoice because of partial delivery or open punch list items. If payment is not received by the due date, interest will accrue on all unpaid amounts at the rate of 1.5 % per month. Custom orders may be subject to a 50% deposit. Maximum account Credit limit is \$50,000, unless otherwise authorized in writing by AYRSONICS. Accounts with an overdue balance in excess of 15 days may be subject to having their terms revoked. All claims arising from invoices must reach AYRSONICS within five (5) business days from the date of the invoice.

SUSPENSION:

In the event that the Purchaser defaults in the payments of any sum due to AYRSONICS, or in the event that the Purchaser's financial condition becomes unsatisfactory to AYRSONICS, AYRSONICS shall have the right, upon notice to the Purchaser, to suspend or discontinue shipment of any Goods until payment has been remitted without incurring any liability to the Purchaser for non-delivery or delay in delivery.

Cash payment or security satisfactory to AYRSONICS may be required by AYRSONICS for future deliveries. AYRSONICS may require cash payments in advance for future deliveries, or may terminate any contract in total, and the Purchaser shall be liable for all costs incurred by AYRSONICS including but not limited to, attorney fees, collection agency fees, accrued interest, and administrative fees.

TAXES:

Prices are in the currency indicated on the AYRSONICS Order Acknowledgment. The prices shown in the EzoBord price list do not include any provincial, or federal, or local taxes. All such taxes applicable to the sale of the products are the responsibility of the Purchaser and any tax or taxes will be added to the invoice as a separate charge to be paid by the Purchaser. If the Purchaser claims an exemption from any tax, the Purchaser shall submit to the Seller the appropriate exemption certificates.

CODE RESTRICTION:

All EzoBord products may be subject to fire and/or building codes applicable to the specific purpose they are being purchased for. However, since codes may vary from area to area, the Purchaser is solely responsible for the proper application of the purchased EzoBord items within the limitation of such codes.

TOLERANCES:

All dimensions must be limited by a specified tolerance. When not specified it is understood that AYRSONICS normal tolerances and standards shall apply. Dimensions in the EzoBord price list are shown in both inches and mm. The metric dimensions are the more accurate, that is, imperial dimensions may be rounded up or down. When Purchaser has submitted own plans and/or specifications, AYRSONICS will not be responsible for the design and fitting of parts. The conforming of AYRSONICS products to the specified tolerance is sufficient evidence as to the correctness of the product. Standards of finish, quality, and appearance shall, unless specified in writing, be the normal standards of AYRSONICS.

LIMITED WARRANTY:

AYRSONICS warrants the construction and the finish of all our products to be free from defects in materials, and workmanship for a period of one (1) year from the date of purchase. This warranty does not apply to components not manufactured by AYRSONICS which are subject to the specific warranties of those manufacturers, if any. AYRSONICS cannot be held responsible for variations in dye lot from order to order. All EzoBord sheet goods are subject to a reasonable degree of variation in color and material thickness. This possibility should be expected by the Purchaser. Repair or replacement of any defective component covered by the AYRSONICS warranty will be made at no charge to the original Purchaser during the warranty period. Labor required to facilitate the repair or replacement will be the responsibility of the original selling dealer. This warranty policy does not apply to defects resulting from negligence, misuse, alteration, improper cleaning, stains, or accidents. AYRSONICS judgment will be final in all matters concerning the condition of the products, the cause or nature of the defect, and the necessity or manner of repair. This warranty applies to products sold in Canada only, and is made only to the original Purchasers acquiring our products through authorized dealers, directly from AYRSONICS, or from other specifically authorized to sell our products.

SHIPPING:

At time of order entry, Purchaser must select one of two methods of freight payment.

- 1.Ex Works - point of shipment, freight collect
- 2.Freight On Board (F.O.B)

Unless otherwise agreed upon in writing, delivery of the Goods shall take place at the address specified by the Purchaser on the date specified by AYRSONICS. The Purchaser shall make all arrangements necessary to take delivery of the Goods whenever they are tendered for delivery. The date of shipment specified by AYRSONICS is an estimate only. Time for delivery shall not be of the essence of the contract. If AYRSONICS is unable to ship the Goods for reasons beyond its control, then AYRSONICS shall be entitled to place the Goods in storage until such a time as delivery may be effective.

RISK, TITLE, AND FREIGHT CLAIMS:

If Goods are sold via Ex Works, the Purchaser incurs all transport costs. AYRSONICS is not responsible for damage which may occur in transit or in storage.

The carrier signs for all goods received and it is the Purchaser's responsibility to examine goods upon receipt and to file any claims for any concealed damage to the products in accordance with the carrier's terms and conditions, within five (5) days of delivery. All packaging should be retained for inspection by the carrier. Failure

by the Purchaser to make any claim against AYRSONICS within five (5) days shall constitute acceptance of the goods and a waiver of the right to return due to defects, errors or shortages.

If Purchaser chooses to have AYRSONICS arrange for shipping, the Goods are F.O.B, and FREIGHT is added to the order/invoice as a separate line item. AYRSONICS will ship the Products using their preferred freight carrier. Risk of loss or damage to the Products shall transfer to the Purchaser from the time of delivery or deemed delivery. The Purchaser shall be entitled to replacement Goods where the Goods have been damaged during transportation. The Purchaser must notify AYRSONICS within 24 hours of receipt of Goods. Packing slip must be signed off as "received as damaged at the time of receipt" by the Purchaser Ownership/ title of the Products shall not pass to the Purchaser until AYRSONICS has received payment in full for all the Products and all other sums due to AYRSONICS from the Purchaser on any account. In the event that AYRSONICS does not receive payment, AYRSONICS reserves the right to reclaim all delivered Goods.

METHODS OF SHIPPING AND ROUTING:

AYRSONICS reserves the right to select the method of transportation and carrier of choice for any shipment. If product is shipped to the Purchaser's or dealers dock, such docking facilities shall be equipped to handle a 53' tractor trailer with appropriate personnel to off-load the truck. Neither AYRSONICS nor the carrier is responsible for offloading the truck. Product that cannot be delivered as above may be delivered to a warehouse, with redelivery at Purchaser's expense.

If requested shipping date is more than 90 days from the date of order, AYRSONICS shall have the right to use the published list price effective at the time of shipment. After 30 days the order may be subject to storage fees. AYRSONICS will not accept charges for expense incurred by the Purchaser in expediting shipments. AYRSONICS will not accept charges for the repair of damage by others.

STORAGE:

In the event the Purchaser requests postponement of delivery beyond the scheduled shipping date after the Goods have become work in progress, or at the time when AYRSONICS is about to make shipment, AYRSONICS may transfer the Goods to storage for Purchaser's account and at Purchaser's risk and expense. Such transfer to storage shall be deemed delivery to Purchaser for all purposes, including invoicing and payment. After 30 days, the Purchaser may be subject to a minimum of \$50/month or \$1.50/square foot/month in storage fees.

LEAD TIMES:

Lead times are as follows:

- Raw materials such as sheets and hardware: 3-4 business days after payment has been received in full.
- Standard products: 4-5 weeks upon approval of shop drawings and deposit payments being received.
- Custom products: 4-6 weeks upon approval of shop drawings and deposit payments being received.
- Printing: 6-8 weeks upon approved shop drawings and deposit payments being received.
- Shop Drawings: Are allotted 3 business days for completion. Custom products may require additional time. Large orders may be subject to staggered delivery dates and lead times.

DELAYS:

AYRSONICS Order Acknowledgment will state a shipping date which is AYRSONICS best estimate at the time the order is acknowledged. However, AYRSONICS shall not incur any obligation or liability to Purchaser for failure to arrive by a specified date.

FORCE MAJEURE:

AYRSONICS shall not be under any liability for any failure to supply goods or otherwise to perform the contract from any cause whatsoever beyond AYRSONICS direct control. AYRSONICS shall not be liable for any loss or damage resulting from any delay or failure in shipment or order failure to perform all or any part of the agreement between the parties with respect to the goods shown on the order acknowledgment where such delay, failure, loss, or damage is the proximate result of any act of any government authority or political subdivision thereof, revolution, riot, civil disorder or disturbance, act of enemies, delay or default in transportation, strike disputes among or between labor unions or other labor disputes, delay or inability in obtaining material and facilities, fire, flood, act of God or any cause not within reasonable control of the company, whether of the class of causes enumerated or otherwise. Without limiting the generality of the foregoing. AYRSONICS may, without causing breach or incurring liability, allocate goods which are in short supply, irrespective of the reasons therefore, among Purchasers, in any manner which AYRSONICS, in its sole discretion, deems advisable.



DESIGN
DRIVEN
ACOUSTICS

CANADA

Ayrsonics Inc - Ontario

825 Trillium Drive
Kitchener, Ontario N2R 1J9
P: 1-844-441-1122
sales@ayrsonics.com

Ayrsonics Inc - Alberta

#9112 – 52nd St. S.E.
Calgary, Alberta T2C 5A9
P: 1-844-441-1122
sales@ayrsonics.com

UNITED STATES

Ayrsonics Mid West LLC

170 Prairie Lake Rd
East Dundee, IL 60118
P: 1-800-517-0686
sales@mw.ayrsonics.com

Ayrsonics New England

32 Hampshire Rd
Salem, NH 03079
P: 603-824-9338 ext. 3001
P: 603-327-4349
sales@ne.ayrsonics.com

Ayrsonics Southwest

1700 1st Street
San Fernando, CA 91340
P: 213-833-9700
sales@sw.ayrsonics.com

EzoBord Head Office

6845 Rexwood Road,
Unit 7 Mississauga, ON L4V 1S5 Canada
FAX +1 416 665 3571
info@ezobord.com

FOLLOW US

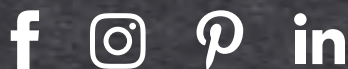

EzoBord.com