

A modern office environment with a clean, minimalist aesthetic. The space features long, light-colored desks with adjustable legs. Each workstation is equipped with a large monitor, a keyboard, and a pair of headphones. Ergonomic office chairs with mesh backs and adjustable bases are positioned at the desks. The office is divided into workstations by green perforated privacy screens. In the background, there are purple decorative panels with a circular pattern. The ceiling is high with exposed ductwork and modern, rectangular pendant lights. A person is seated at a desk in the background, working on a computer. The overall atmosphere is professional and contemporary.

OFFICE CATALOG  
2025

ezo  
BOARD



# OFFICE CATALOG

New and improved, this specification guide is your reference for the most important product information.

All dimensions are listed widest point to tallest point. Dimensions are nominal. Some sizes such as cell density vary by overall unit width and length. For more details on the size and shape of a product, technical shop drawings are provided at order point and available upon request. For more detail, please contact your local sales representative.

Listed SKUs within this catalogue do not include EzoBord color information. Ensure inclusion of color selected when ordering to avoid delays.

All products are priced as listed, and without suspension hardware. Recommendations on best hardware for application are available through your local sales representative. Some products may have variation in manufacturing based on mounting or suspension. Specify intended application with order to ensure compatibility.

Custom patterns, shapes, and sizes are always welcome. Please contact customer service for accurate pricing on custom products.

## INDEX

<b>COLORS</b> .....	4
<b>FURNITURE</b>	
BENCH SCREEN SYSTEM.....	6
DESK SCREEN SYSTEM .....	8
DESK RETURN SCREEN .....	10
HOODY .....	12
HOODY DESKTOP COVE .....	14
KAYRA CURVED SCREEN .....	16
KULMA CORNER SCREEN .....	18
MODESTY SCREEN .....	20
MODESTY PANEL.....	21
OBI MOBILE OFFICE DIVIDER .....	22
PRIVASEAT.....	24
PYRAMID MOBILE WHITEBOARD .....	26
SUSPENDED OFFICE .....	28
WORK ZONE DIVIDER .....	30
<b>HARDWARE</b> .....	32
<b>CUT TYPES</b> .....	34
CONDITION OF SALE, RETURN POLICY & WARRANTY.....	36

# COLOR SPLASH



Select from our standard catalog of six base colors. Looking for more colors? Our color library is both broad and deep.

Simply scan the associated QR code to explore the many options we have to satisfy your discerning palette of choice.



**SCAN TO SEE EXTENDED  
COLOR RANGE HERE**

OFFICE

# BENCH SCREEN SYSTEM

Absorb sound, improve speech intelligibility, and ensure privacy in offices with multiple workstations using EzoBord's Bench Screen System. More than just an office desk divider, it adds color and style with an acoustic solution that fits any manufacturer's furniture system. Configurations are available to accommodate any back-to-back workstation system and can be infinitely linked together.



CODE K L S - X X - X X - X X - X X - X X - X X - X X X X  
 PRODUCT SHAPE CODE HEIGHT1 HEIGHT2 THICKNESS COLOR

STYLE

CONFIGURATIONS: 2 Station | 4 Station | 6 Station

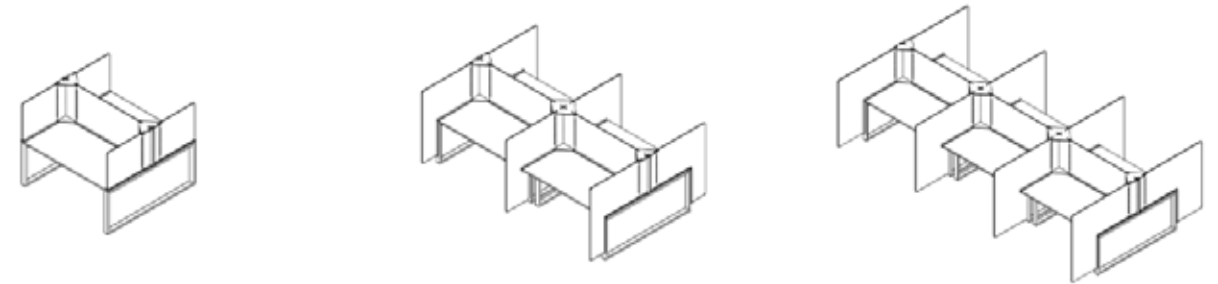

DIMENSIONS

DESKTOP RETURN

CODE DR  
**R: 31"** 96mm  
**H: 23"** 585mm

MEDIUM RETURN

CODE MR  
**R: 42"** 1076mm  
**H: 47"** 1194mm

FULL RETURN

CODE FR  
**R: 53"** 1343mm  
**H: 47"** 1194mm

DESKTOP DEPTH D

**48"** 1219mm  
**60"** 1524mm

DESKTOP WIDTH W

**48"** 1219mm  
**60"** 1524mm  
**72"** 1828mm

THICKNESS

**1/2"** 12mm

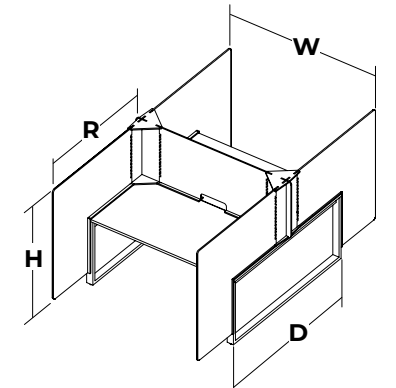
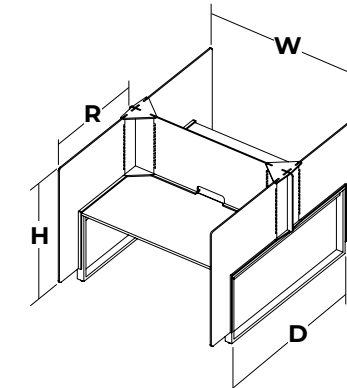
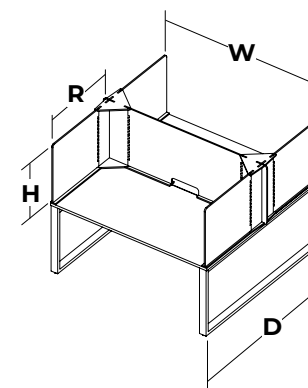

Standard cable management/monitor arm cut-out: 11" (280mm) w x 3" (75mm) h

COLOR CODE

<b>DESERT SAND</b> CODE DS10	<b>BRICK RED</b> CODE BR34	<b>CHARCOAL GRAY</b> CODE CG06	<b>SILVER GRAY</b> CODE SG04	<b>MOSS GREEN</b> CODE MG10	<b>ROYAL BLUE</b> CODE RB08

Please add color code on all orders: example PYR-24-69-PW-WB-12-DS10

Custom sizes available on request. Design charges may apply.

Colors may change and are subject to availability. Refer to website for details or contact your local sales representative.

All dimensions indicated are nominal

# OFFICE DESK SCREEN SYSTEM

EzoBord Desk Screens are a great way to absorb sound, add privacy, color and style in any open plan workspace, enhancing speech intelligibility making every office space a better place to work in. EzoBord desk screens are a welcome addition to any open plan office and are totally customizable for size, shape, hole pattern and color. They are also available in single or double layer to fit any budget or design. EzoBord desk screens are a great, eco-friendly alternative to fabriccovered desk screens.



CODE D S C - X X X - X X - X X - X X - X X X X  
PRODUCT    STYLE    WIDTH    THICKNESS    COLOR

**CIRCULAR**  
CODE CIR

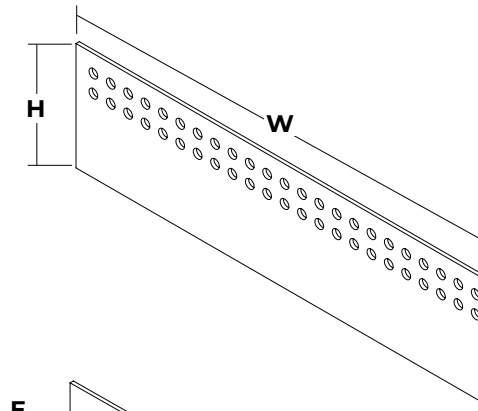

**ELLIPTICAL**  
CODE ELP

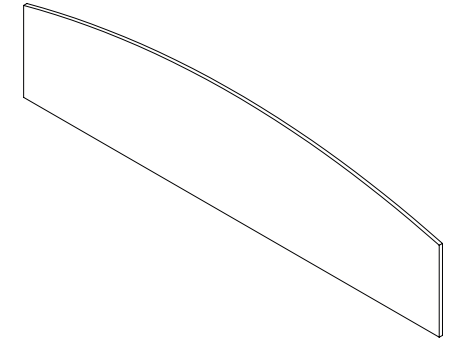

**RECTANGLE**  
CODE REC

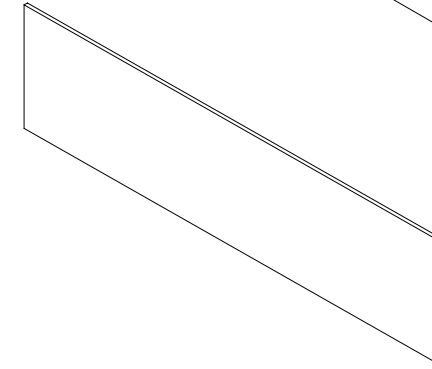

**RECTANGLE**  
CODE REC

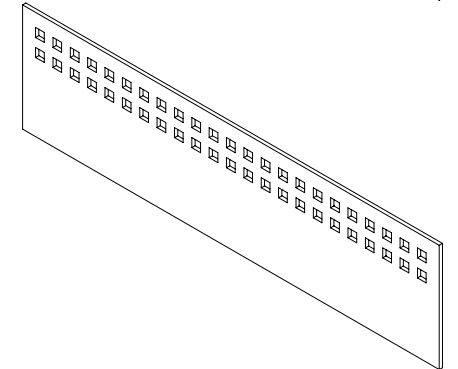

WIDTH	HEIGHT	THICKNESS
48" 1219mm	15" 381mm	1/2" 12mm
60" 1524mm	24" 609mm	3/8" 9mm
72" 1824mm		



## COLOR CODE



<b>DESERT SAND</b> CODE DS10	<b>BRICK RED</b> CODE BR34	<b>CHARCOAL GRAY</b> CODE CG06	<b>SILVER GRAY</b> CODE SG04	<b>MOSS GREEN</b> CODE MG10	<b>ROYAL BLUE</b> CODE RB08
---------------------------------	-------------------------------	-----------------------------------	---------------------------------	--------------------------------	--------------------------------

Please add color code on all orders: example PYR-24-69-PW-WB-12-DS10

Custom sizes available on request. Design charges may apply.

Colors may change and are subject to availability. Refer to website for details or contact your local sales representative.

All dimensions indicated are nominal

OFFICE

# DESK RETURN SCREEN

Desk Return Screens are a simple and effective way to ensure privacy and deaden sound between bench style desks and workstations. Available in a range of both colors and high performance acoustic properties.

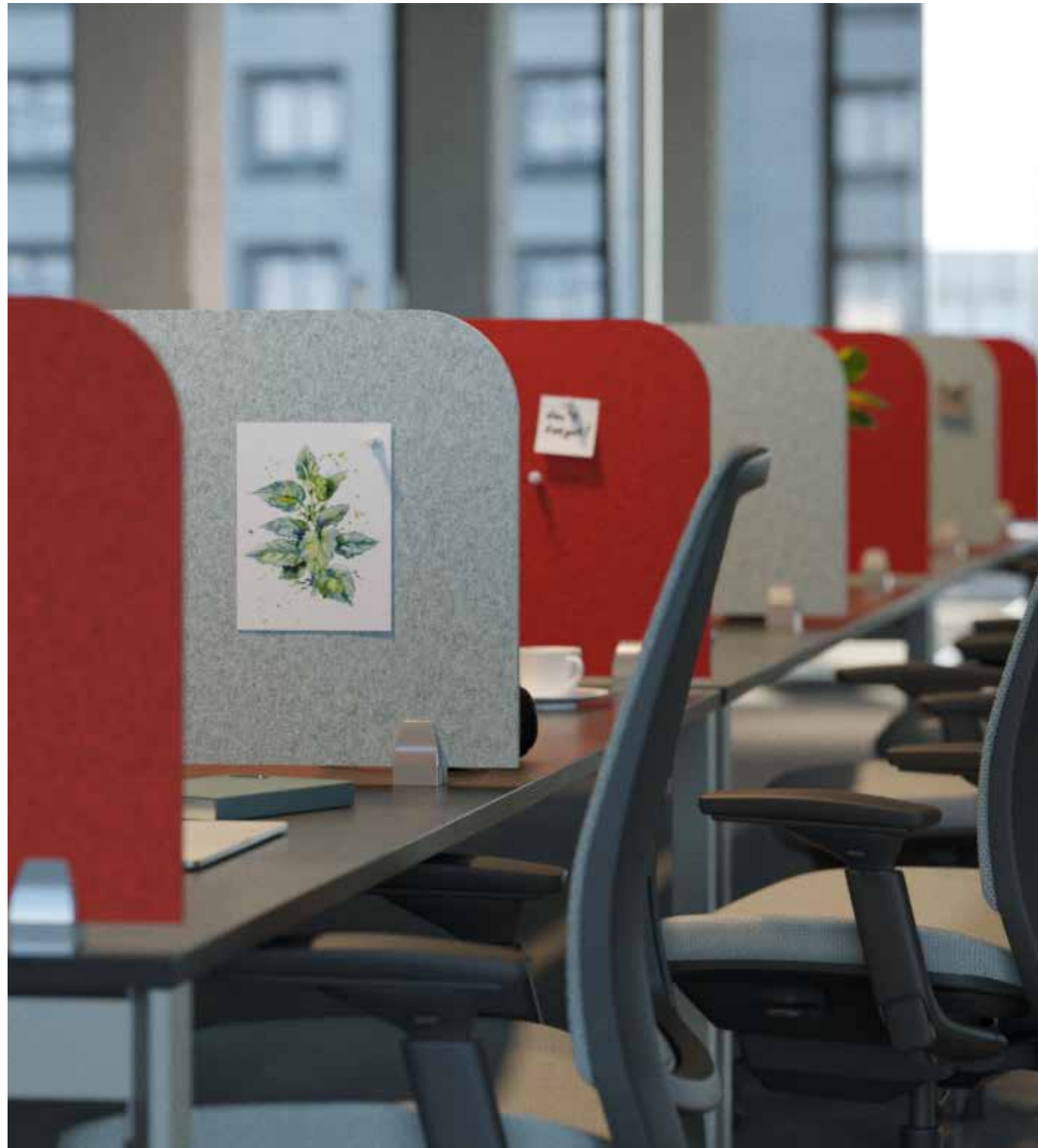

CODE **R T S - X X - X X - X X - X X X X**  
PRODUCT DEPTH HEIGHT THICKNESS COLOR



RTS-24-16-12-SG04



RTS-30-16-12-RB08



RTS-24-24-12-MG10



DEPTH	HEIGHT	THICKNESS
20" 508mm	16" 406mm	1/2" 12mm
24" 609mm		3/8" 9mm
30" 762mm		

### COLOR CODE



**DESERT SAND**  
CODE DS10



**BRICK RED**  
CODE BR34



**CHARCOAL GRAY**  
CODE CG06



**SILVER GRAY**  
CODE SG04



**MOSS GREEN**  
CODE MG10



**ROYAL BLUE**  
CODE RB08

Please add color code on all orders: example PYR-24-69-PW-WB-12-DS10

Custom sizes available on request. Design charges may apply.

Colors may change and are subject to availability. Refer to website for details or contact your local sales representative.

All dimensions indicated are nominal

# OFFICE HOODY

Instantly transform your open plan office space into individually separated, quiet workspaces with EzoBord's modular Hooded Desk divider system nicknamed "Hoody". The "Hoody" installs in seconds without the use of any tools and fits onto any new or existing desking/benching system. Compatible with virtually any manufacturer including all major office furniture brands.

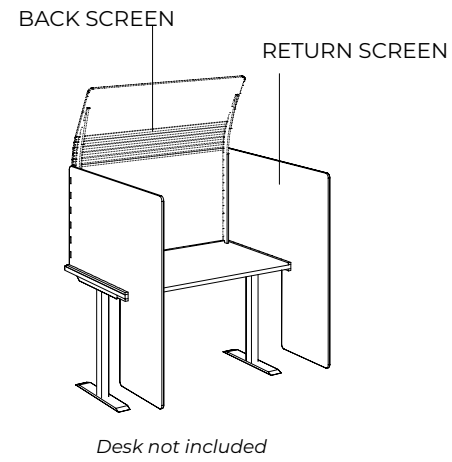

## BACK SCREEN

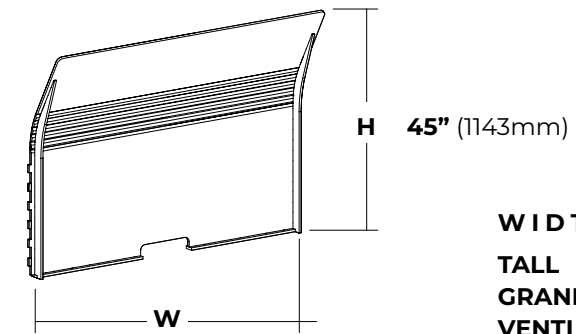

CODE **H D S - B S X - X X - X X - X X - X X X X**  
PRODUCT SIZE CODE WIDTH HEIGHT THICKNESS COLOR

### WIDTH

TALL 48" (1219mm) CODE **BST**  
 GRANDE 60" (1219mm) CODE **BSG**  
 VENTI 72" (1828mm) CODE **BSV**

### HEIGHT

45" (1143mm)

## RETURN SCREEN

### FULL HEIGHT RETURN SCREEN

CODE **FRS**

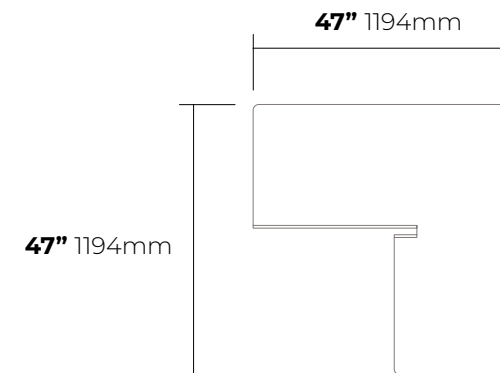

CODE **H D S - R S X - X X - X X - X X - X X X X**  
PRODUCT STYLE DEPTH HEIGHT THICKNESS COLOR

### EXTENDED RETURN SCREEN

CODE **ERS**

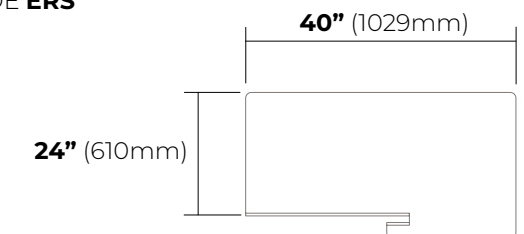

### RETURN SCREEN

CODE **RTS**

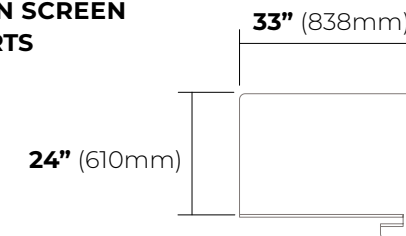

## COLOR CODE



**DESERT SAND** CODE DS10    **BRICK RED** CODE BR34    **CHARCOAL GRAY** CODE CG06    **SILVER GRAY** CODE SG04    **MOSS GREEN** CODE MG10    **ROYAL BLUE** CODE RB08

Please add color code on all orders: example PYR-24-69-PW-WB-12-DS10

Custom sizes available on request. Design charges may apply.

Colors may change and are subject to availability. Refer to website for details or contact your local sales representative.

All dimensions indicated are nominal

OFFICE

# HOODY DESKTOP

Instantly transform your open plan office space into individually separated, quiet workspaces with EzoBord's modular Hooded Desk divider system nicknamed "Hoody". The "Hoody" installs in seconds without the use of any tools and fits onto any new or existing desking/benching system. Compatible with virtually any manufacturer including all major office furniture brands.



CODE **HDC - DTX - XX - XX - XX - XX - XXXX**  
PRODUCT      STYLE      DEPTH      WIDTH      HEIGHT      THICKNESS      COLOR

STYLE

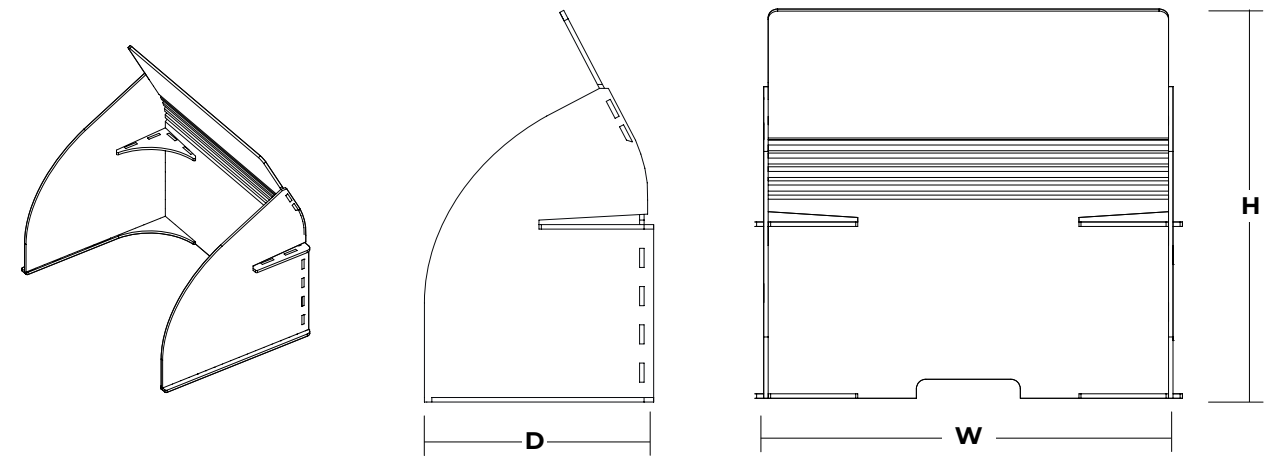

	WIDTH	DEPTH	HEIGHT	THICKNESS
TALL CODE DTT	48" (1219mm)	24" (609mm)	40" (1040mm)	1/2" (12mm)
GRANDE CODE DTG	60" (1219mm)	30" (762mm)	40" (1040mm)	1/2" (12mm)
VENTI CODE DTV	72" (1828mm)	30" (762mm)	40" (1040mm)	1/2" (12mm)



COLOR CODE

DESERT SAND CODE DS10	BRICK RED CODE BR34	CHARCOAL GRAY CODE CG06	SILVER GRAY CODE SG04	MOSS GREEN CODE MG10	ROYAL BLUE CODE RB08

Please add color code on all orders: example PYR-24-69-PW-WB-12-DS10

Custom sizes available on request. Design charges may apply.

Colors may change and are subject to availability. Refer to website for details or contact your local sales representative.

All dimensions indicated are nominal

OFFICE

# KAYRA CURVED SCREEN

Kayra Curved Screens are a simple but elegant way to divide and soundproof open plan spaces. Available in a range of finishes and in a full curve or wave shape, they work in any interior space. Multiple Kayra Curved Screens can infinitely connect together to make a wide variety of shapes and sizes that create custom acoustical meeting spaces!



CODE **K A Y - X X X - X X - X X - X X - X X - X X X X**  
 PRODUCT    SHAPE CODE    DEPTH    WIDTH    HEIGHT    THICKNESS    COLOR

## KAYRA SCREEN MODULE

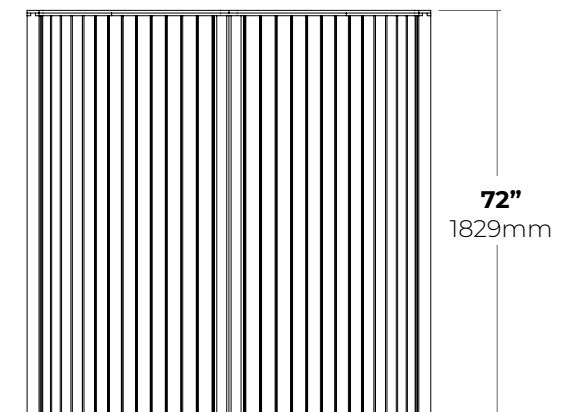
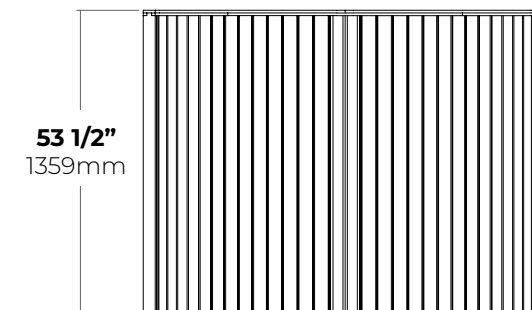
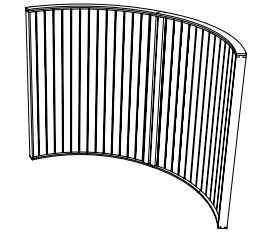
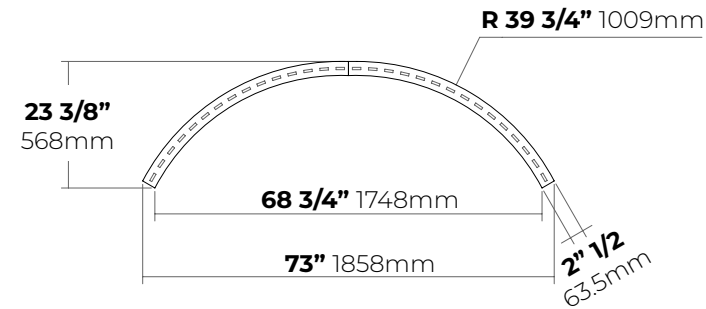

## COLOR CODE



<b>DESERT SAND</b> CODE DS10	<b>BRICK RED</b> CODE BR34	<b>CHARCOAL GRAY</b> CODE CG06	<b>SILVER GRAY</b> CODE SG04	<b>MOSS GREEN</b> CODE MG10	<b>ROYAL BLUE</b> CODE RB08
---------------------------------	-------------------------------	-----------------------------------	---------------------------------	--------------------------------	--------------------------------

Please add color code on all orders: example PYR-24-69-PW-WB-12-DS10

Custom sizes available on request. Design charges may apply.

Colors may change and are subject to availability. Refer to website for details or contact your local sales representative.

All dimensions indicated are nominal

OFFICE

# KULMA CORNER SCREEN

Kulma Corner Screens absorb sound, divide space and ensure complete privacy at your workspace. Available in a range of styles and colors to suit any office interior.



CODE K L S - X X - X X - X X - X X - X X - X X - X X X X  
PRODUCT SHAPE CODE HEIGHT1 HEIGHT2 THICKNESS COLOR

**SINGLE HEIGHT**

CODE SH

**VARIABLE HEIGHT**

CODE VH

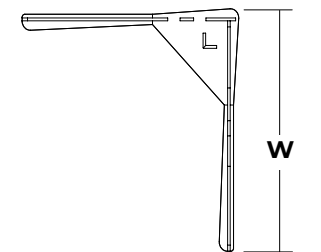
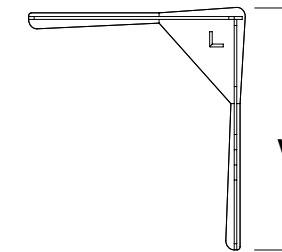
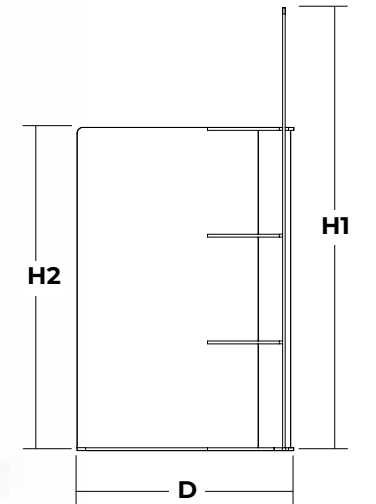
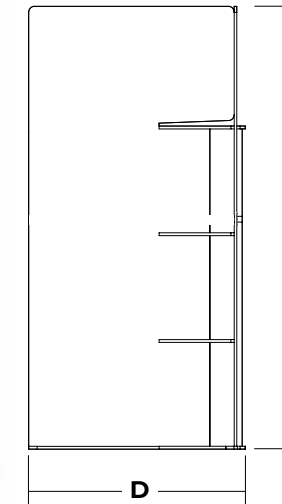

DEPTH	WIDTH	HEIGHT H1	HEIGHT H2	THICKNESS
40" (1016mm)	73" (1854mm)	73" (1855mm)	73" (1855mm) 53" (1346mm)	1/2" (12mm)

**COLOR CODE**

					
DESERT SAND CODE DS10	BRICK RED CODE BR34	CHARCOAL GRAY CODE CG06	SILVER GRAY CODE SG04	MOSS GREEN CODE MG10	ROYAL BLUE CODE RB08

Please add color code on all orders: example PYR-24-69-PW-WB-12-DS10

Custom sizes available on request. Design charges may apply.

Colors may change and are subject to availability. Refer to website for details or contact your local sales representative.

All dimensions indicated are nominal

OFFICE

# MODESTY SCREEN

CODE M D S - X X X - X X - X X - X X - X X X X  
PROD- STYLE THICKNESS COLOR

EzoBord Modesty Screens are a great way to absorb sound, add privacy, color, and style in any open plan workspace. It enhances speech intelligibility making every office space a better place to work. This product is a welcome addition to any open plan office and is totally customizable for size, shape, hole pattern, and color. It is also available in single or double layer to accommodate any budget or design. EzoBord Desk Screens are a great eco-friendly alternative to fabric-covered desk screens.



STYLE

RECTANGLE

CODE REC

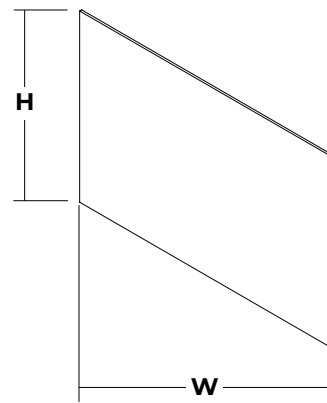

ELIPTICAL

CODE ELP

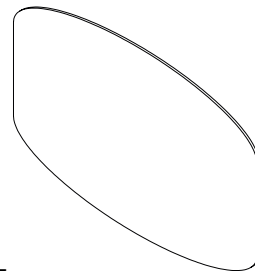

CRECENT

CODE CRS

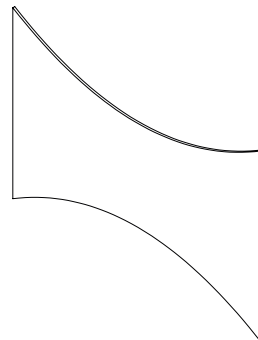

**WIDTH**  
 48" (1219mm)  
 60" (1219mm)  
 72" (1828mm)

**HEIGHT**  
 48" (1219mm)

**THICKNESS**  
 1/2" (12mm)

COLOR CODE



DESERT SAND CODE DS10    BRICK RED CODE BR34    CHARCOAL GRAY CODE CG06    SILVER GRAY CODE SG04    MOSS GREEN CODE MG10    ROYAL BLUE CODE RB08

Please add color code on all orders: example PYR-24-69-PW-WB-12-DS10  
 Custom sizes available on request. Design charges may apply.  
 Colors may change and are subject to availability. Refer to website for details or contact your local sales representative.  
 All dimensions indicated are nominal

OFFICE

# MODESTY PANEL

CODE M D P - X X X - X X - X X - X X - X X X X  
PROD- STYLE THICKNESS COLOR

EzoBord Modesty Screens are a great way to absorb sound, add privacy, color, and style in any open plan workspace. It enhances speech intelligibility making every office space a better place to work. This product is a welcome addition to any open plan office and is totally customizable for size, shape, hole pattern, and color. It is also available in single or double layer to accommodate any budget or design. EzoBord Desk Screens are a great eco-friendly alternative to fabric-covered desk screens.



STYLE

RECTANGLE

CODE REC

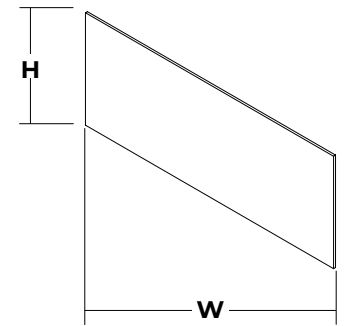

ELIPTICAL

CODE ELP

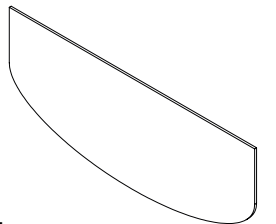

CRECENT

CODE CRS

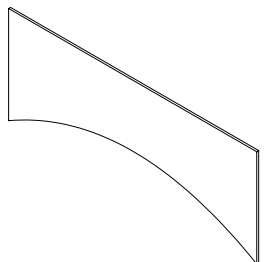

**WIDTH**  
 48" (1219mm)  
 60" (1219mm)  
 72" (1828mm)

**HEIGHT**  
 24" (610mm)

**THICKNESS**  
 1/2" (12mm)

OFFICE  
**OBI** MOBILE OFFICE DIVIDER

OBI Mobile office dividers are the perfect way to instantly transform any space into places where people meet, collaborate, share and learn.

Ruggedly built, totally mobile and 'nestable', OBI Office Dividers feature EzoBord acoustical surface materials and are available in a variety of visually interesting patterns. OBI office dividers are also available with magnetic rewriteable surface options and shelf and file storage options making them perfect for mutli task/meeting environments



CODE O B 2 - E Z O - X X - X X - X X X - X X X - X X X X  
PRODUCT    STYLE    WIDTH    HEIGHT    PATTERN    COLOR (BASE LAYER\*)    COLOR (SURFACE LAYER\*)

**STYLE**

**PLAIN BOTH SIDES** CODE EZO

**PLAIN ONE SIDE, WHITEBOARD OTHER SIDE** CODE PLW

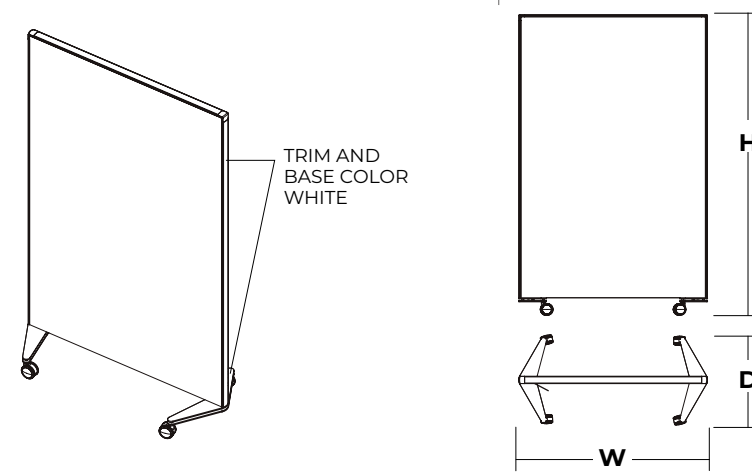

**HEIGHT**  
60" (1219mm)  
72" (1828mm)

**WIDTH**  
48" (1219mm)

**WHITEBOARD SHELF**  
CODE OB2-SHF-47-08-12

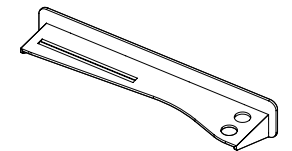

**WHITEBOARD SHELF**  
CODE OB2-FIL-15-14-12

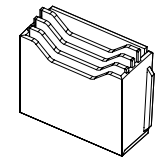

**OPTIONAL PATTERNS**



**BAMBOO**  
CODE BAM

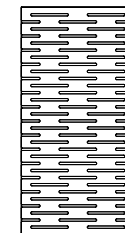

**SLOTTED**  
CODE SLT



**STAGGERED**  
CODE STG

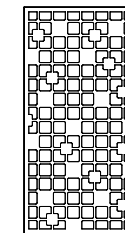

**LATTICE**  
CODE LIT

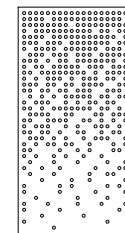

**PIXELATED CIRCLES**  
CODE PXC

**COLOR CODE**



**DESERT SAND**  
CODE DS10



**BRICK RED**  
CODE BR34



**CHARCOAL GRAY**  
CODE CG06



**SILVER GRAY**  
CODE SG04



**MOSS GREEN**  
CODE MG10



**ROYAL BLUE**  
CODE RB08

**SUGGESTED CONFIGURATIONS**



Please add color code on all orders: example PYR-24-69-PW-WB-12-DS10

Custom sizes available on request. Design charges may apply.

Colors may change and are subject to availability. Refer to website for details or contact your local sales representative.

All dimensions indicated are nominal

OFFICE  
**PRIVASEAT**

One of the greatest challenges in the office is creating collaborative, open, social workplaces, while maintaining a sense of personal space for employees. PrivaSeat takes personal workplace privacy to the next level. It is the only workplace accessory that shelters the user, providing actual visual and audio privacy.

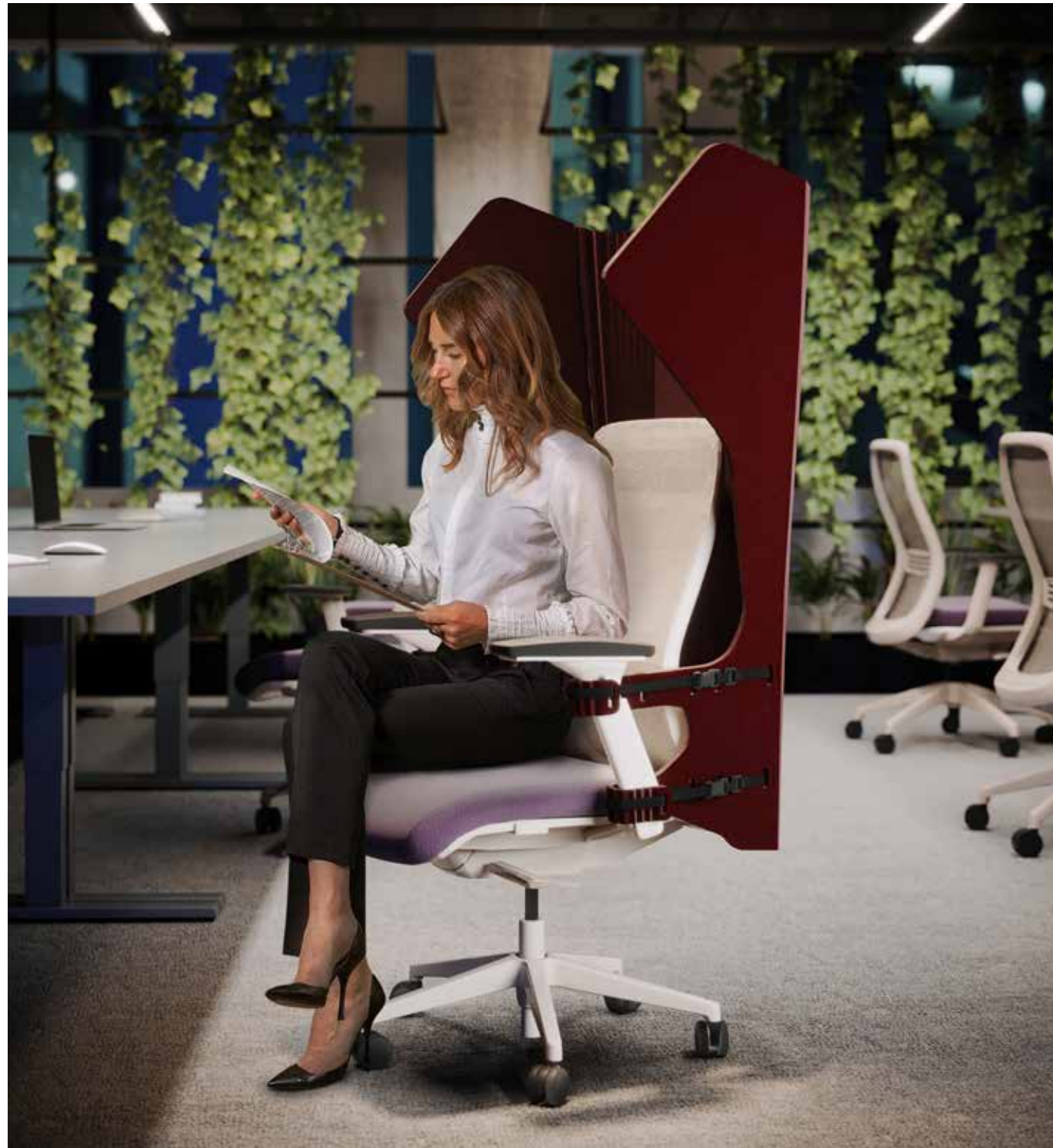

CODE **P V S - X X X - X X X X - X X X X**  
 PRODUCT FINISH FINISH COLOR COLOR

**DIMENSIONS**

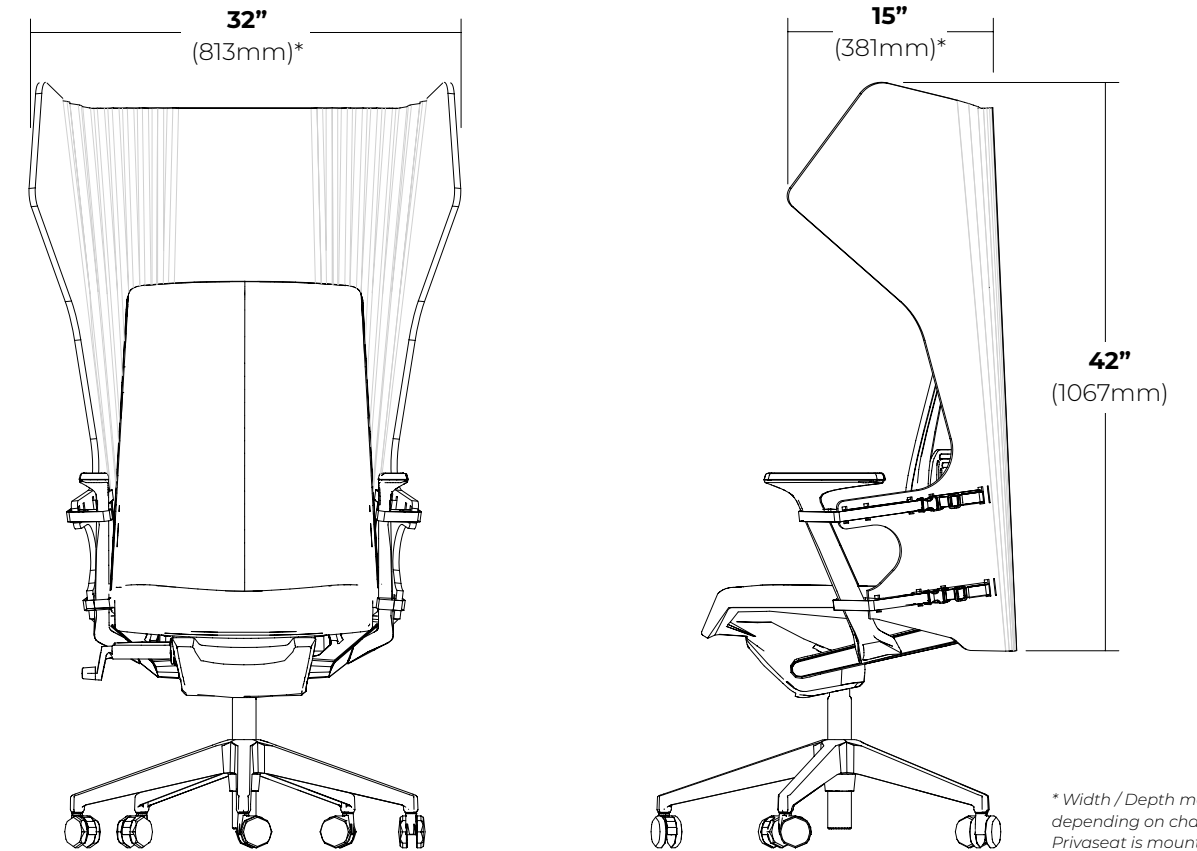

\* Width / Depth may vary depending on chair model PrivaSeat is mounted to.

**COLOR CODE**



**DESERT SAND** CODE DS10    **BRICK RED** CODE BR34    **CHARCOAL GRAY** CODE CG06    **SILVER GRAY** CODE SG04    **MOSS GREEN** CODE MG10    **ROYAL BLUE** CODE RB08

Please add color code on all orders: example PYR-24-69-PW-WB-12-DS10  
 Custom sizes available on request. Design charges may apply.  
 Colors may change and are subject to availability. Refer to website for details or contact your local sales representative.  
 All dimensions indicated are nominal

OFFICE  
**PYRAMID**

Pyramid is a free standing, wipeable, dry erase, mobile whiteboard with the added feature of a handy power/USB source. Pyramid also features acoustic panels for added sound deadening and mitigation in open plan office spaces.



CODE P Y R - X X - X X - X X - X X X X  
PRODUCT DEPTH HEIGHT THICKNESS COLOR

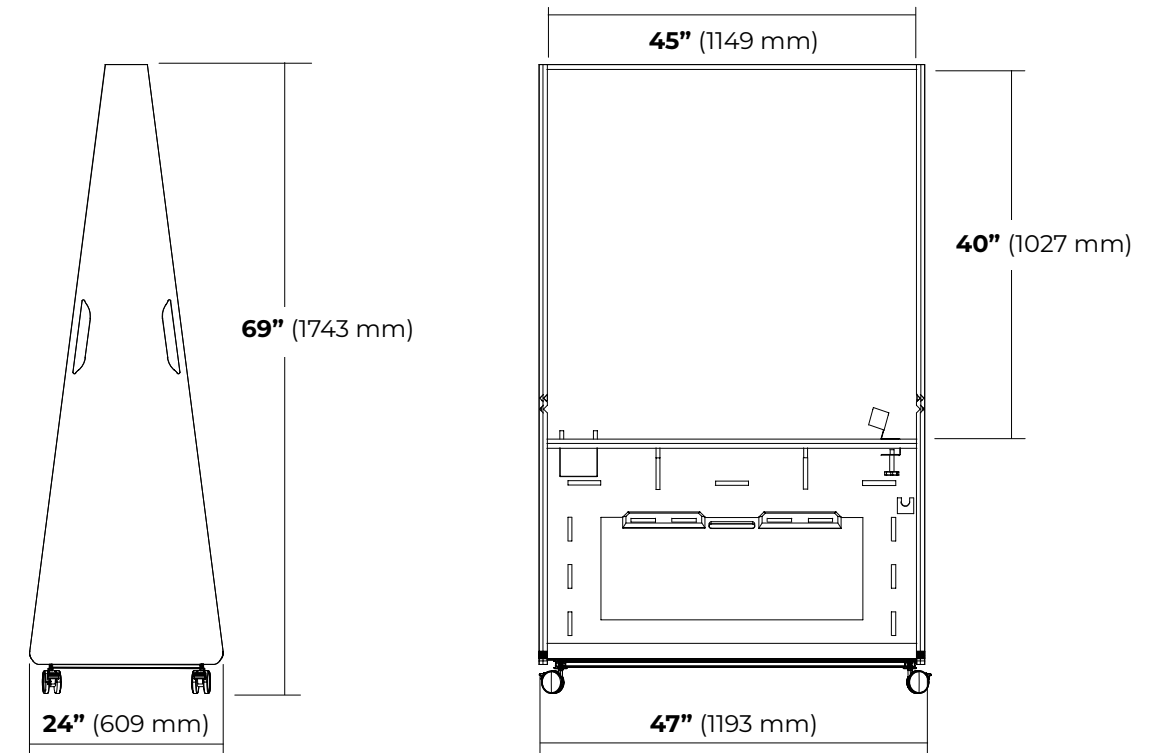

**POWER MODULE**  
CODE PYR-PWR



**WHITEBOARD**  
CODE P Y R - W B R



**COLOR CODE**

					
<b>DESERT SAND</b> CODE DS10	<b>BRICK RED</b> CODE BR34	<b>CHARCOAL GRAY</b> CODE CG06	<b>SILVER GRAY</b> CODE SG04	<b>MOSS GREEN</b> CODE MG10	<b>ROYAL BLUE</b> CODE RB08

Please add color code on all orders: example PYR-24-69-PW-WB-12-DS10

Custom sizes available on request. Design charges may apply.

Colors may change and are subject to availability. Refer to website for details or contact your local sales representative.

All dimensions indicated are nominal

# OFFICE SUSPENDED OFFICE

There really isn't a "one size fits all" solution, privacy encompasses many different needs and behaviors, each form of privacy – acoustical, informational or visual, helps people to feel free, to share ideas and to make work visible.

Designed in collaboration with B2Lab, Suspended Office is an ecosystem of spaces that re-define the privacy of the work area and shape collaborative work.

Featuring EzoBord acoustical surface materials in a variety of visually interesting patterns, colors, and configurations that perfectly balance design and functionality.



CODE **S U S - X X X - X X X X**  
PRODUCT CONFIG WIDTH LENGTH

## CONFIGURATION OPTIONS

**SINGLE MODULE**  
CODE **SIG**

WIDTH **48"** (1219mm)  
LENGTH **96"** (2438mm)

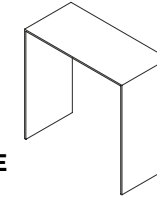

**DOUBLE MODULE**  
CODE **DBL**

WIDTH **96"** (2438mm)  
LENGTH **96"** (2438mm)

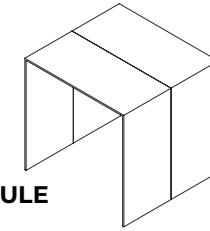

**"L" SHAPE**  
CODE **ELL**

WIDTH **96"** (2438mm)  
LENGTH **144"** (3657mm)

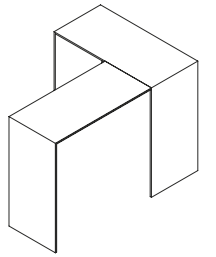

## OPTIONAL PATTERNS

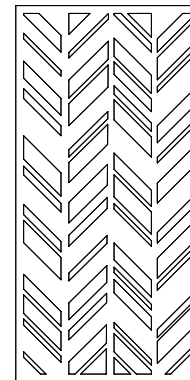

**CHEVRON**  
CODE **CHE**

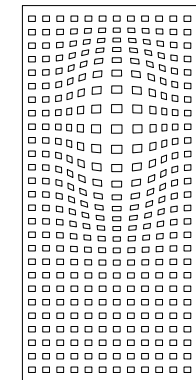

**RECTANGULAR  
UNDULATION**  
CODE **REC**

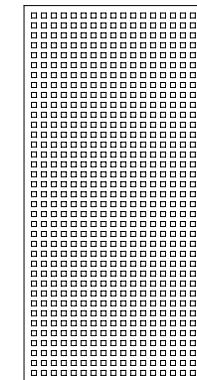

**SQUARES**  
CODE **SQR**

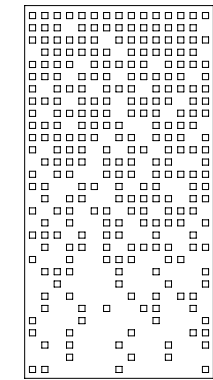

**PIXELATED  
SQUARES**  
CODE **PXS**

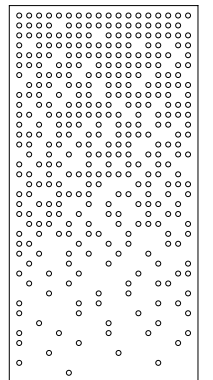

**PIXELATED  
CIRCLES**  
CODE **PXC**

## COLOR CODE



**DESERT SAND**  
CODE **DS10**



**BRICK RED**  
CODE **BR34**



**CHARCOAL GRAY**  
CODE **CG06**



**SILVER GRAY**  
CODE **SG04**



**MOSS GREEN**  
CODE **MG10**



**ROYAL BLUE**  
CODE **RB08**

Please add color code on all orders: example **PYR-24-69-PW-WB-12-DS10**

Custom sizes available on request. Design charges may apply.

Colors may change and are subject to availability. Refer to website for details or contact your local sales representative.

All dimensions indicated are nominal

WALLS

# WORK ZONE DIVIDER MODULAR

Work Zone Dividers Modular have key distinguishing features for the design illuminati. It can be comprised of one, two or three modules allowing you to create a truly spectacular parameter division. Still porous to allow light, but boldly applied for design intent. This product can be mounted in sections at different heights for added effect, something that the standard single piece Work Zone Dividers cannot accomplish.



CODE **W Z M - X X X - X X - X X - 1 2 - X X X X**  
PRODUCT PATTERN WIDTH HEIGHT THICKNESS COLOR

## TIER A PATTERNS

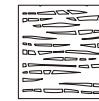

**BAMBOO**  
CODE **BAM**

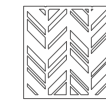

**CHEVRON**  
CODE **CHE**

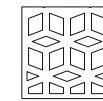

**CUBE**  
CODE **CUB**

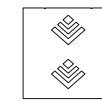

**DECO**  
CODE **DEC**

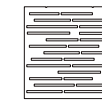

**FLATLINE**  
CODE **FLA**

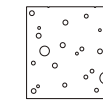

**GALAXY**  
CODE **GLX**



**LEAF**  
CODE **LEA**

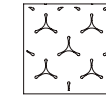

**JACK**  
CODE **JAC**

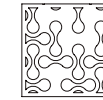

**LAVA**  
CODE **LAV**

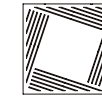

**FOCUS**  
CODE **FOC**

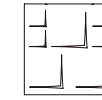

**NOTES PLUS**  
CODE **NOP**

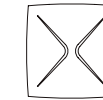

**BOOMERANG**  
CODE **BOO**

## TIER B PATTERNS



**AZTEC**  
CODE **AZ**

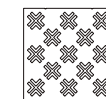

**DOKUMA**  
CODE **DOK**



**KESIK**  
CODE **KES**

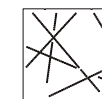

**LAZER**  
CODE **LAZ**

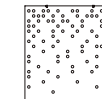

**PIXELATED CIRCLES**  
CODE **PXC**

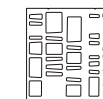

**ORMAN**  
CODE **ORM**

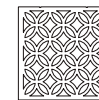

**LATTICE**  
CODE **LAT**

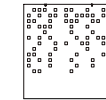

**PIXELATED SQUARES**  
CODE **PXS**

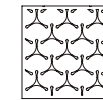

**SCALES**  
CODE **SCA**

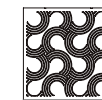

**PHOTON**  
CODE **PHO**

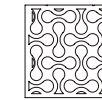

**HOURGLASS**  
CODE **HOU**

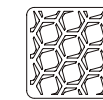

**HIVE**  
CODE **HIE**

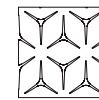

**TURBINE**  
CODE **TUR**

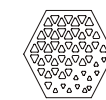

**HONEYCOMB**  
CODE **HOU**



**SONAR**  
CODE **SON**



**HATCH**  
CODE **HAT**

## CONFIGURATIONS

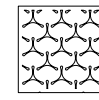

47.5" (1206mm)

1 MODULE

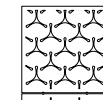

95" (2413mm)

2 MODULES

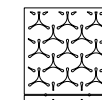

142.5" (3619mm)

3 MODULES

## COLOR CODE



**DESERT SAND**  
CODE **DS10**



**BRICK RED**  
CODE **BR34**



**CHARCOAL GRAY**  
CODE **CG06**



**SILVER GRAY**  
CODE **SG04**



**MOSS GREEN**  
CODE **MG10**



**ROYAL BLUE**  
CODE **RB08**

Please add color code on all orders: example **PYR-24-69-PW-WB-12-DS10**

Custom sizes available on request. Design charges may apply.

Colors may change and are subject to availability. Refer to website for details or contact your local sales representative.

All dimensions indicated are nominal

# HARDWARE GUIDE

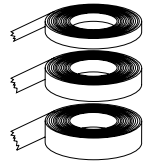

## EZO TAPE *Sold Individually*

Specially formulated permanent double sided tape for vertical wall application. Not for use on all types of surface finishes. Available in three widths at 164' (50m) length rolls

- DST-010 1" (25mm)
- DST-015 1.5" (38mm)
- DST-020 2" (50mm)



## 1" STAND OFF / STO-25 *Sold Individually*

1/2" (13mm) Diameter, 1" (25mm) Depth.

For wall application only. Intended for use with 3/8" (9mm) - 1/2" (12mm) material.

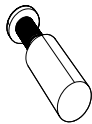

## 2" STAND OFF / STO-50 *Sold Individually*

1"(25mm) Diameter, 2" (50mm) Depth.

For wall application only. Intended for use with 3/8" (9mm) - 1/2" (12mm) material.



## UPPER SUSPENSION HOUSING / CF6-01 *Sold Individually*

Ceiling fitting to be used with mechanical fastener.

Includes 13'-1 1/2" (4m) of cable. Brass Locator accepts #8 Screws, not included.



## LOWER SUSPENSION HOUSING / CF6-02 *Sold Individually*

For use with Wire Suspension Track. Includes 13'-1 1/2" (4m) of wire.

Not intended for ceiling suspension applications.



## WIRE SUSPENSION TRACK *Sold Individually*

To be used with Upper and/or Lower Suspension Housing.

Specify brass slot nuts for housing attachments. Available in two lengths:

- XC-04-1000 39" (1.000mm)
- XC-04-2000 80" (2.036mm)

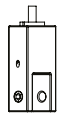

## ADJUSTABLE COMBINATION CLAMP / CBG-C *Sold Individually*

Compatible with Upper and Lower Suspension Housing.

Intended for use with 3/8" (9mm) and 1/2" (12mm) material. Specify placement on material for use with larger thicknesses.



## DOUBLE EZO CLAMP / CVD *Sold Individually*

Clamp intended to connect two 3/8" (9mm) pieces of material. Specify placement on material for use with alternate thicknesses.



## LOOPING CABLE GRIPPER / CG7250 *Sold Individually*

Adjustable wire looping system. Compatible with Upper Suspension Housing or Eye Hook application.

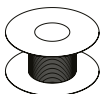

## CABLE

1/16" wire. Compatible with all EzoBord hardware options.

- Spools of 250' (76m)
- Spools of 100' (30.48m)



## EYE HOOK / EY001 *Sold in Packages of 50*

For use with individually suspended baffles.

Not recommended for ceiling application.

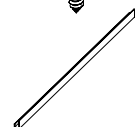

## ALUMINIUM J TRIM / FR3138 *Sold in 8' lengths*

For use with 3/8" (9mm) material only.

Available in lengths up to 8'(2.43m) Minimum order requirements may apply.

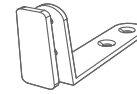

## PJ 15/17 UNDER MOUNT MODESTY BRACKET

Compatible with 1/2" (12mm) and 11/16" (18mm) material

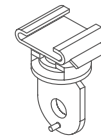

## T-BAR CLIP W/ RIVETS

Compatible with standard 15/16" (24mm)t-grid systems

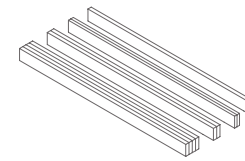

## EZO STANDOFF

EzoBord Standoff 4' length (for wall applications only)

- 1/2" (12mm)
- 11/16" (18mm)
- 15/16" (24mm)
- 1-113/127(48mm)

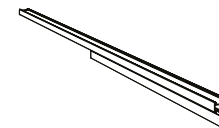

## FREE RUNNING SYSTEM

Sliding track system for full sheets or work zone dividers.

Wall application requires Wall Mount Brackets.

Available with 3/8" (9mm) material only.

- TRK-396-WHT
- TRK-296-WHT

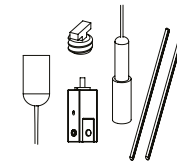

## COMPLETE SUSPENSION KIT / K-WZDC *Sold Individually*

For use with Work Zone Dividers. Ezo on ezo.

Includes:

- 2x Wire Suspension Track 39" (990mm)
- 2x Upper Suspension Housing
- 2x Lower Suspension Housing
- 4x Adjustable Combination Clamp

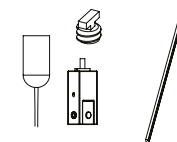

## UPPER SUSPENSION KIT / K-WZDU *Sold Individually*

For use with Work Zone Dividers. Ezo on ezo.

Includes:

- 1x Wire Suspension Track
- 2x Upper Suspension Housing
- 2x Adjustable Combination Clamp

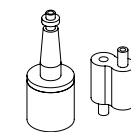

## FOUR WAY SUSPENSION COUPLER / GR-1/4-20 *Sold Individually*

For use with Circle Geo Clouds only.

Includes:

- 1x Four Hole Suspension Unit
- 1x 120" (3048mm) Cable
- 4x Looping Cable Gripper



## SURFACE MOUNT DESK SCREEN BRACKET / PJ3 *Sold Individually*

Compatible with material 1/2" (12mm), or 11/16" (18mm) thick.



## SURFACE MOUNT DESK SCREEN BRACKET LARGE / PJ9 *Sold Individually*

Compatible with material 1/2" (12mm), 11/16" (18mm) or 15/16" (24mm) thick.

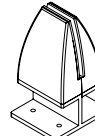

## UNDER MOUNT DESK SCREEN DIVIDER BRACKET / PJ101 *Sold Individually*

Compatible with material 1/2" (12mm) or 11/16" (18mm) thick.

Surface thickness limited to 1" (25mm) - 1 1/4" (69mm)

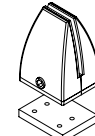

## UNDER MOUNT DESK SCREEN BRACKET / PJ4

Compatible with material 12mm or 18mm thick.

Surface thickness limited to 1" (25mm) - 1 1/4" (69mm)

# CUT TYPES

## EDGE OPTIONS

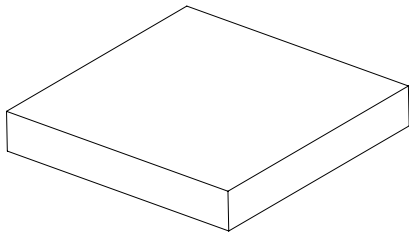

STRAIGHT EDGE

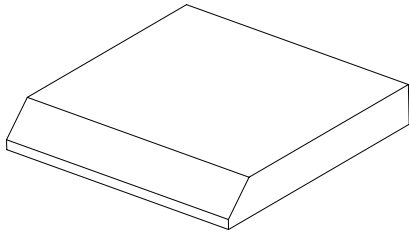
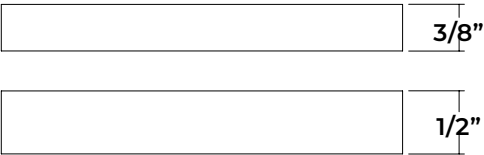

BEVELED

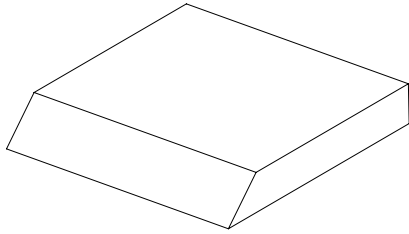
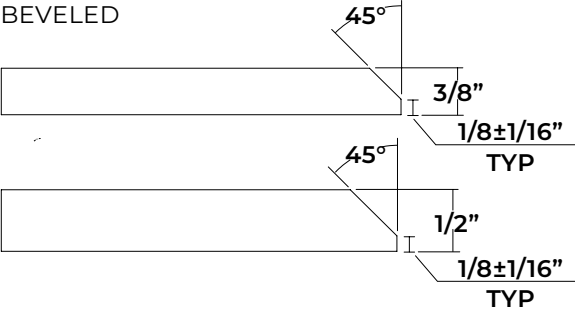

CHAMFERED

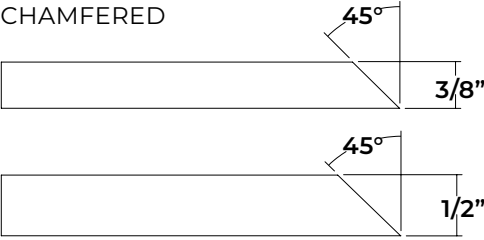

## CORNER OPTIONS

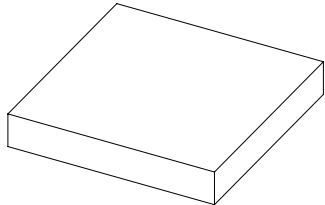
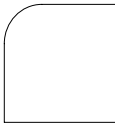
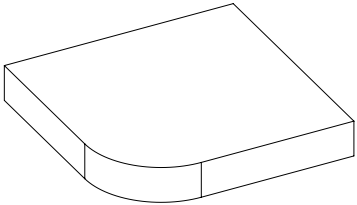

SQUARE



## SURFACE OPTIONS

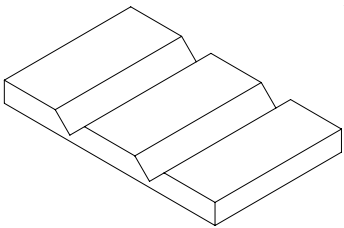

V NOTCH

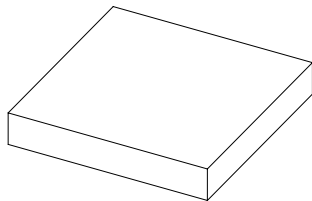

## CONDITION OF SALE, RETURN POLICY & WARRANTY FOR AYRSONICS INC.

### DEFINITIONS

“Purchaser” refers to the organization or person who accepts a quotation or offer for the sale of “Goods” from the Seller.

“Seller” refers to [ ] or as [ASSIGNEE] “Goods” or “Products” refers to the articles to be supplied to the Purchaser by the AYRSONICS INC. All “Products” are made-to-order, with the exception of raw materials such as sheets and hardware.

“Quotation” or “Quote” is the calculated cost on requested products based on specifications provided by the Purchaser to AYRSONICS INC.

“Order” refers to a purchase order, a blanket purchase agreement, a blanket purchase order, a job or work order, or other mechanism for ordering Products.

“Shop Drawings” refer to a set of drawings produced by AYRSONICS INC to depict Preliminary, Quote-Level, Proposal, Sign-off, Manufacturing, and Installation details pertinent to the successful completion of a project. All drawings are submitted to the Purchaser by AYRSONICS INC.

“Design Partner” refers to any organization or person who may make a significant contribution to the intellectual direction of a research proposal or a research project.

“Project” shall mean the research activities necessary to achieve a research, development, and /or formation, objective of a design proposal, or design idea. The deliverables of which address a technical or functional ability.

“Background Intellectual Property” refers to any and all intellectual property conceived, developed, made or acquired by AYRSONICS INC prior to the collaboration of a Project, with a Design Partner or Purchaser.

### GOVERNING PROVISIONS:

These Terms and Conditions govern any Quotation, Order Acknowledgment, Invoice, or any agreement, order, or sale that may result from any contract, and is expressly limited to and made conditional upon these Terms and Conditions becoming part of the Agreement between the Purchaser and the Seller [AYRSONICS INC]. Any variation to these Terms and Conditions contained herein, whether contained in a request for Quotation, Purchase Order, or other document by the Purchaser Including any special Terms and Conditions agreed upon between the parties are hereby objected to and shall be inapplicable unless agreed to in writing by AYRSONICS INC.

### SALES QUOTE INFORMATION:

Acceptance of the quotation by the Purchaser constitutes a binding agreement. Prices quoted by AYRSONICS INC are based on standard EzoBord products as detailed in the Price and Product Guide and on information provided by the Purchaser. Any changes to standard EzoBord products including but not limited to size or pattern, will be classified as a “custom” product. Pricing of custom

products is based on specifications provided by Purchaser and will be priced at the discretion of AYRSONICS INC.

Additional charges may apply where the scope of work varies from that set out in the quote. Prices are prepared in Canadian dollars. Delivery and taxes may be subject to change and are based on point of transfer. AYRSONICS INC does not provide quotes for installation. Quotes are valid for a period of 30 days, after which pricing may change.

Possession of the EzoBord Price List or any other literature shall not imply AYRSONICS INC willingness to sell to the holders and shall not be constructed as a direct offer of sale. AYRSONICS INC reserves the right to make changes at any time and without prior notice to prices, colors, materials, specifications, design, and models offered in the price list, as well as discontinue product at any time without prior notice.

### ORDER INFORMATION:

AYRSONICS INC requires that all orders be submitted in writing. All orders which require fabrication shall include detailed shop drawings. Once all specifics (size, thickness, pattern, color etc.) have been confirmed, the Purchaser will receive an Order Acknowledgment which will outline items ordered, pricing, ship-to and bill-to details. Orders with missing, or incorrect information may delay lead times. A production date cannot be established until Purchaser has provided all related information and documents, such as deposit payments, and signed shop drawings pertaining to the order. If the Purchaser does not agree with any details outlined in the Order Acknowledgment, AYRSONICS INC must be notified by email within three business days of receiving the Order Acknowledgment. All orders are subject to a minimum net charge of \$250.

### SHOP DRAWINGS:

If the purchase order requires shop drawings, AYRSONICS INC shall coordinate all such drawings, will review them for accuracy, completeness, and compliance with purchase order requirements. Sign-off by Purchaser constitutes acceptance of all technical details depicted in the drawings; including all dimensions, colors, patterns, quantities, and design criteria. Sign-off is a requirement for the initiation of AYRSONICS INC fabrication. Information contained in the Shop Drawings are the sole property of AYRSONICS INC. Any reproduction in part or as a whole without the written permission of AYRSONICS INC is prohibited.

### RESEARCH, DEVELOPMENT, RESULTS, AND INTELLECTUAL PROPERTY:

The Purchaser and/or Design Partner agrees that any CONDITION OF SALE, RETURN POLICY & WARRANTY FOR AYRSONICS INC INC.

design proposal, shop drawing, or rendering, including but not limited to, specifications, formulae, improvements, processes, methods, techniques, prototypes, data, reports,

or discoveries, contains proprietary information and material is owned by AYRSONICS INC and is protected by applicable intellectual property legislation. The Purchaser and/or Design Partner may not use the Intellectual Property for any purpose other than that contracted in a written agreement between AYRSONICS INC and the Purchaser.

A written collaboration agreement shall be signed by the Purchaser and/or Design Partner before any research project is initiated. Purchaser and/or Design Partner agrees any Design Proposals or Research Project Design intent, preliminary design, or design development shall be performed by, in collaboration with, or under the direct supervision of AYRSONICS INC. All written and oral information and material disclosed or provided by AYRSONICS INC to the Purchaser is confidential information. The Purchaser shall use all reasonable endeavors not to disclose to any third party any Confidential Information nor use for any purpose except expressly permitted by AYRSONICS INC. Purchaser may be required to sign a Non-disclosure Agreement. All Background Intellectual Property used in connection with the Project shall remain the property of AYRSONICS INC. AYRSONICS INC has the right to reuse methods and approaches developed under this agreement in other projects for other purposes.

### PRINT PROGRAM:

A digital proof sign-off is required prior to manufacturing. Sign-off by Purchaser constitutes acceptance of all technical details depicted in the digital proof. A digital proof does not guarantee correct color matching. Physical proof must be requested by Purchaser to verify final color of product as there may be a variation between the digital proof and printed product. AYRSONICS INC shall not be liable for any deviations, errors, and faults that remained unnoticed in the proofs that were approved by the Purchaser or for any spelling or grammatical errors in the graphic file provided by the Purchaser.

### CHANGES AND CANCELLATIONS:

After AYRSONICS INC acknowledgment of a Purchaser's order, the order may not be changed or canceled by Purchaser without the written consent of AYRSONICS INC. Orders already in production may not be eligible for cancellation or change or may be subject to a cancellation fee, restocking fee, and payment for all product which has been cut, at the discretion of AYRSONICS INC management. If the order requires major changes, the order may be sent back to the quoting department for new pricing. [Major changes may include but are not limited to the addition of new items, dimension, pattern, and design feature changes]. Sheet order changes after payment may be subject to a cancellation or a change order fee of 25%. AYRSONICS INC reserves the right to cancel an order at any time.

### RETURNS, CLAIMS, AND INQUIRIES:

All return requests are handled by AYRSONICS INC authorized dealers or AYRSONICS INC Customer Service Department. All return requests must be submitted within 30 days from date of receipt. No returns of goods will be accepted without consent and shipping instructions from AYRSONICS INC. If authorized, Purchaser must complete AYRSONICS INC Product Return Request Form and ship all product to AYRSONICS INC within one week of receiving the Product Return Request Form. All authorized return of goods must be securely packaged by the Purchaser in order to reach AYRSONICS INC without damage. A minimum restocking charge of 50% on fabricated products, is made on all authorized returns for credit or refund, provided goods are received by AYRSONICS INC in the condition in which they left the factory. Raw materials such as sheets and hardware are subject to a minimum 25% restocking fee. No credit will be given if goods cannot be reused. Custom order items are in no event subject to return.

### PRICE AND PAYMENT:

All published prices are list prices. Prices on an Order Acknowledgment are net. Any products sold is the property of AYRSONICS INC and shall remain AYRSONICS INC property until fully paid. The Purchaser agrees to perform all acts which may be necessary to assure retention of title to such products to AYRSONICS INC, until such time as the goods have been paid for in full. Invoices will be sent by AYRSONICS INC to the Purchaser and will be as detailed in the Order Acknowledgment and in accordance with the agreed schedule in the Order Acknowledgment. Not included in the list price is special or export packing, freight, unpacking or installation. A 50% deposit amount against the total amount of the project, is required for Cash in Advance Purchasers, prior to scheduling production. The 50% final payment must be received by AYRSONICS INC prior to shipping. Sheet orders require a 100% deposit for Cash in Advance Purchasers.

### N15 TERMS:

Purchaser on terms shall pay invoices within 15 days after the date of shipment or pickup, subject to the Purchaser passing credit approval. All payments are fully due. Purchaser agrees not to withhold payment on any invoice because of partial delivery or open punch list items. If payment is not received by the due date, interest will accrue on all unpaid amounts at the rate of 1.5 % per month. Custom orders may be subject to a 50% deposit. Maximum account Credit limit is \$50,000, unless otherwise authorized in writing by AYRSONICS INC. Accounts with an overdue balance in excess of 15 days may be subject to having their terms revoked. All claims arising from invoices must reach AYRSONICS INC within five (5) business days from the date of the invoice.

**SUSPENSION:**

In the event that the Purchaser defaults in the payments of any sum due to AYRSONICS INC, or in the event that the Purchaser's financial condition becomes unsatisfactory to AYRSONICS INC, AYRSONICS INC shall have the right, upon notice to the Purchaser, to suspend or discontinue shipment of any Goods until payment has been remitted without incurring any liability to the Purchaser for non-delivery or delay in delivery.

Cash payment or security satisfactory to AYRSONICS INC may be required by AYRSONICS INC for future deliveries. AYRSONICS INC may require cash payments in advance for future deliveries, or may terminate any contract in total, and the Purchaser shall be liable for all costs incurred by AYRSONICS INC including but not limited to, attorney fees, collection agency fees, accrued interest, and administrative fees.

**TAXES:**

Prices are in the currency indicated on the AYRSONICS INC Order Acknowledgment. The prices shown in the EzoBord price list do not include any provincial, or federal, or local taxes. All such taxes applicable to the sale of the products are the responsibility of the Purchaser and any tax or taxes will be added to the invoice as a separate charge to be paid by the Purchaser. If the Purchaser claims an exemption from any tax, the Purchaser shall submit to the Seller the appropriate exemption certificates.

**CODE RESTRICTION:**

All EzoBord products may be subject to fire and/or building codes applicable to the specific purpose they are being purchased for. However, since codes may vary from area to area, the Purchaser is solely responsible for the proper application of the purchased EzoBord items within the limitation of such codes.

**TOLERANCES:**

All dimensions must be limited by a specified tolerance. When not specified it is understood that AYRSONICS INC normal tolerances and standards shall apply. Dimensions in the EzoBord price list are shown in both inches and mm. The metric dimensions are the more accurate, that is, imperial dimensions may be rounded up or down. When Purchaser has submitted own plans and/or specifications, AYRSONICS INC will not be responsible for the design and fitting of parts. The conforming of AYRSONICS INC products to the specified tolerance is sufficient evidence as to the correctness of the product. Standards of finish, quality, and appearance shall, unless specified in writing, be the normal standards of AYRSONICS INC.

**LIMITED WARRANTY:**

AYRSONICS INC warrants the construction and the finish of all our products to be free from defects in materials, and workmanship for a period of one (1) year from the date of purchase. This warranty does not apply to components not manufactured by AYRSONICS INC which are subject to the specific warranties of those manufacturers, if any. AYRSONICS INC cannot be held responsible for variations in dye lot from order to order. All EzoBord sheet goods are subject to a reasonable degree of variation in color and material thickness. This possibility should be expected by the Purchaser. Repair or replacement of any defective component covered by the AYRSONICS INC warranty will be made at no charge to the original Purchaser during the warranty period. Labor required to facilitate the repair or replacement will be the responsibility of the original selling dealer. This warranty policy does not apply to defects resulting from negligence, misuse, alteration, improper cleaning, stains, or accidents. AYRSONICS INC judgment will be final in all matters concerning the condition of the products, the cause or nature of the defect, and the necessity or manner of repair.

This warranty applies to products sold in Canada only, and is made only to the original Purchasers acquiring our products through authorized dealers, directly from AYRSONICS INC, or from other specifically authorized to sell our products.

**SHIPPING:**

At time of order entry, Purchaser must select one of two methods of freight payment.

- 1.Ex Works - point of shipment, freight collect
- 2.Freight On Board (F.O.B)

Unless otherwise agreed upon in writing, delivery of the Goods shall take place at the address specified by the Purchaser on the date specified by AYRSONICS INC. The Purchaser shall make all arrangements necessary to take delivery of the Goods whenever they are tendered for delivery. The date of shipment specified by AYRSONICS INC is an estimate only. Time for delivery shall not be of the essence of the contract. If AYRSONICS INC is unable to ship the Goods for reasons beyond its control, then AYRSONICS INC shall be entitled to place the Goods in storage until such a time as delivery may be effective.

**RISK, TITLE, AND FREIGHT CLAIMS:**

If Goods are sold via Ex Works, the Purchaser incurs all transport costs. AYRSONICS INC is not responsible for damage which may occur in transit or in storage.

The carrier signs for all goods received and it is the Purchasers responsibility to examine goods upon receipt and to file any claims for any concealed damage to the products in accordance with the carrier's terms and conditions, within five (5) days of delivery. All packaging should be retained for inspection by the carrier. Failure

by the Purchaser to make any claim against AYRSONICS INC within five (5) days shall constitute acceptance of the goods and a waiver of the right to return due to defects, errors or shortages.

If Purchaser chooses to have AYRSONICS INC arrange for shipping, the Goods are F.O.B, and FREIGHT is added to the order/invoice as a separate line item. AYRSONICS INC will ship the Products using their preferred freight carrier. Risk of loss or damage to the Products shall transfer to the Purchaser from the time of delivery or deemed delivery. The Purchaser shall be entitled to replacement Goods where the Goods have been damaged during transportation. The Purchaser must notify AYRSONICS INC within 24 hours of receipt of Goods. Packing slip must be signed off as "received as damaged at the time of receipt" by the Purchaser Ownership/ title of the Products shall not pass to the Purchaser until AYRSONICS INC has received payment in full for all the Products and all other sums due to AYRSONICS INC from the Purchaser on any account. In the event that AYRSONICS INC does not receive payment, AYRSONICS INC reserves the right to reclaim all delivered Goods.

**METHODS OF SHIPPING AND ROUTING:**

AYRSONICS INC reserves the right to select the method of transportation and carrier of choice for any shipment. If product is shipped to the Purchaser's or dealers dock, such docking facilities shall be equipped to handle a 53' tractor trailer with appropriate personnel to off-load the truck. Neither AYRSONICS INC nor the carrier is responsible for offloading the truck. Product that cannot be delivered as above may be delivered to a warehouse, with redelivery at Purchaser's expense.

If requested shipping date is more than 90 days from the date of order, AYRSONICS INC shall have the right to use the published list price effective at the time of shipment. After 30 days the order may be subject to storage fees. AYRSONICS INC will not accept charges for expense incurred by the Purchaser in expediting shipments. AYRSONICS INC will not accept charges for the repair of damage by others.

**STORAGE:**

In the event the Purchaser requests postponement of delivery beyond the scheduled shipping date after the Goods have become work in progress, or at the time when AYRSONICS INC is about to make shipment, AYRSONICS INC may transfer the Goods to storage for Purchaser's account and at Purchaser's risk and expense. Such transfer to storage shall be deemed delivery to Purchaser for all purposes, including invoicing and payment. After 30 days, the Purchaser may be subject to a minimum of \$50/month or \$1.50/square foot/month in storage fees.

**LEAD TIMES:**

Lead times are as follows:

- Raw materials such as sheets and hardware: 3-4 business days after payment has been received in full.
- Standard products: 4-5 weeks upon approval of shop drawings and deposit payments being received.
- Custom products: 4-6 weeks upon approval of shop drawings and deposit payments being received.
- Printing: 6-8 weeks upon approved shop drawings and deposit payments being received.
- Shop Drawings: Are allotted 3 business days for completion. Custom products may require additional time. Large orders may be subject to staggered delivery dates and lead times.

**DELAYS:**

AYRSONICS INC Order Acknowledgment will state a shipping date which is AYRSONICS INC best estimate at the time the order is acknowledged. However, AYRSONICS INC shall not incur any obligation or liability to Purchaser for failure to arrive by a specified date.

**FORCE MAJEURE:**

AYRSONICS INC shall not be under any liability for any failure to supply goods or otherwise to perform the contract from any cause whatsoever beyond AYRSONICS INC direct control. AYRSONICS INC shall not be liable for any loss or damage resulting from any delay or failure in shipment or order failure to perform all or any part of the agreement between the parties with respect to the goods shown on the order acknowledgment where such delay, failure, loss, or damage is the proximate result of any act of any government authority or political subdivision thereof, revolution, riot, civil disorder or disturbance, act of enemies, delay or default in transportation, strike disputes among or between labor unions or other labor disputes, delay or inability in obtaining material and facilities, fire, flood, act of God or any cause not within reasonable control of the company, whether of the class of causes enumerated or otherwise. Without limiting the generality of the foregoing. AYRSONICS INC may, without causing breach or incurring liability, allocate goods which are in short supply, irrespective of the reasons therefore, among Purchasers, in any manner which AYRSONICS INC, in its sole discretion, deems advisable.



DESIGN  
DRIVEN  
ACOUSTICS

## CANADA

---

### Ayrsonics Inc - Ontario

825 Trillium Drive  
Kitchener, Ontario N2R 1J9  
844-441-1122  
sales@ayrsonics.com

### Ayrsonics Inc - Alberta

292236 Nose Creek Boulevard  
Building 1B, Unit #19  
Rocky View County, AB T4A 3N7  
844-441-1122  
sales@ayrsonics.com

### EzoBord Corporate Office

6845 Rexwood Road, Unit 7  
Mississauga, ON L4V 1S5  
416-665-3571  
info@ezobord.com

## UNITED STATES

---

### Ayrsonics Midwest LLC

820 Tollgate Road  
Elgin, IL 60123  
800-517-0686  
sales.amw@ayrsonicsusa.com

### Ayrsonics Southwest LLC

13430 N Dysart Rd. Suite 120  
Surprise, AZ 85379  
213-833-9700  
sales.asw@ayrsonicsusa.com

### Ayrsonics Southeast LLC

15 Enterprise Way  
Dahlonega, GA 30533  
706-539-4711  
sales.ase@ayrsonicsusa.com

## UNITED KINGDOM

---

### EzoBord UK Limited

Unit 20, Westwood Business Park  
Margate, Kent. CT9 4JJ  
+44 1843-264027  
sales@ezobord.co.uk

## IRELAND

---

### EzoBord Ireland Limited

Inniscarra, Main Street,  
Rathcoole, Co. Dublin,  
D24 EO29, Ireland  
+353 1485-4774  
sales@ezobord.ie

## CENTRAL & LATIN AMERICA

---

### EzoBord Costa Rica SRL

100 Sur 25 Oeste Recope  
Bodega #16 Ochomogo, Cartago  
+506 8842-4613  
info-ebcr@ezobord.com

### EzoBord - LATAM

Buenos Aires, Argentina  
+54 9 11 5657-1793  
info-latam@ezobord.com

FOLLOW US    